



RPCED1

DIRECT OPERATED FLOW CONTROL VALVE WITH ELECTRIC PROPORTIONAL CONTROL

SERIES 52

SUBPLATE MOUNTING
ISO 6263-03 (CETOP 03)

p max **250** bar
Q max (see table of performances)

MOUNTING INTERFACE

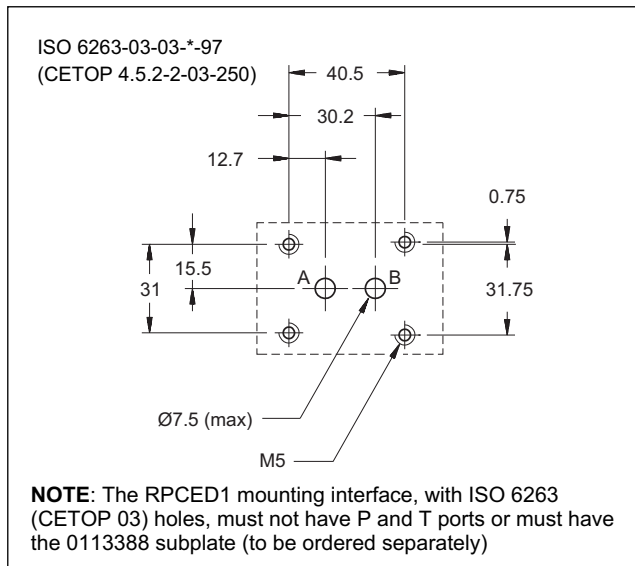

OPERATING PRINCIPLE

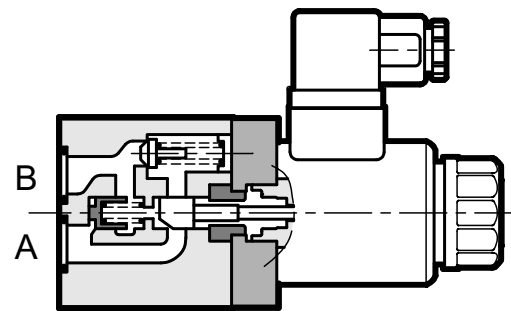

- The RPCED1 valve is a two-way flow control valve with pressure and thermal compensation, electric proportional control, and mounting interface in compliance with ISO 6263 (CETOP RP 121H) standards.
- It is normally used for flow rate control in hydraulic circuit branches or for speed control of hydraulic actuators.
- Flow rate can be modulated continuously in proportion to the current supplied to the solenoid.
- The valve can be controlled directly by a current control supply unit or by means of the relative electronic control units to exploit valve performance to the full (see par. 10).
- It is available in five flow rate control ranges up to 25 l/min.

PERFORMANCES

(obtained with mineral oil with viscosity of 36 cSt at 50°C and electronic control cards)

Maximum operating pressure	bar	250
Minimum Δp between A and B port		10
Maximum controlled flow		1,5 - 4 - 8 - 16 - 25
Min. controlled flow (for 1 and 4 l/min. reg.)	l/min	0,025
Maximum free-reverse flow		40
Step response	see paragraph 7	
Hysteresis (with PWM 100 Hz)	% of p nom	< 6%
Repeatability	% of p nom	< $\pm 2,5\%$
Electrical characteristic	see paragraph 6	
Ambient temperature range	°C	-20 / +50
Fluid temperature range	°C	-20 / +80
Fluid viscosity range	cSt	10 + 400
Fluid contamination degree	According to ISO 4406:1999 class 18/16/13 (class 17/15/12 for flows < 0,5 l/min)	
Recommended viscosity	cSt	25
Mass:	kg	1,5

HYDRAULIC SYMBOLS

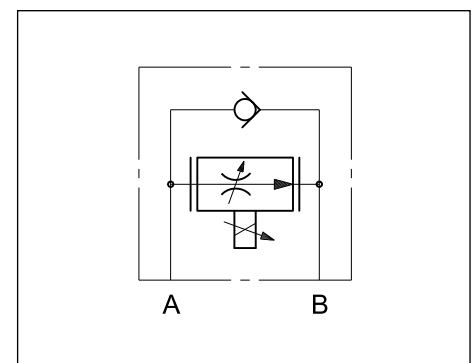

1 - IDENTIFICATION CODE

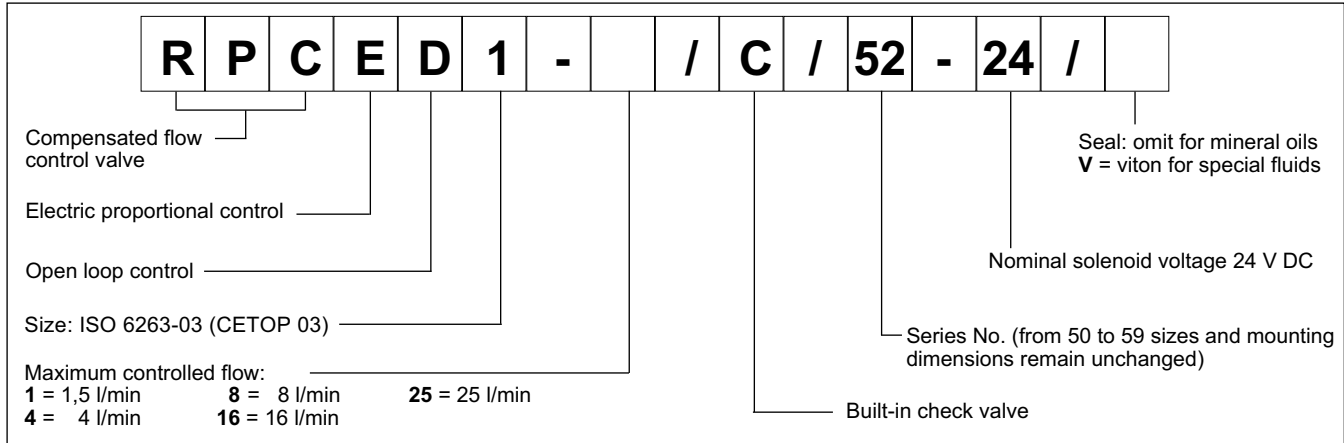

2 - CHARACTERISTIC CURVES (measured with viscosity of 36 cSt at 50°C)

Typical curves for flow rate A → B according to the current supplied to the solenoid for controlled flow rate of: 1- 4 - 8 - 16 - 25 l/min.

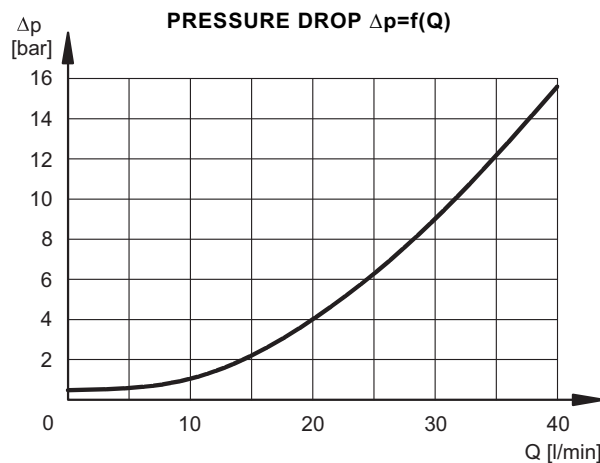
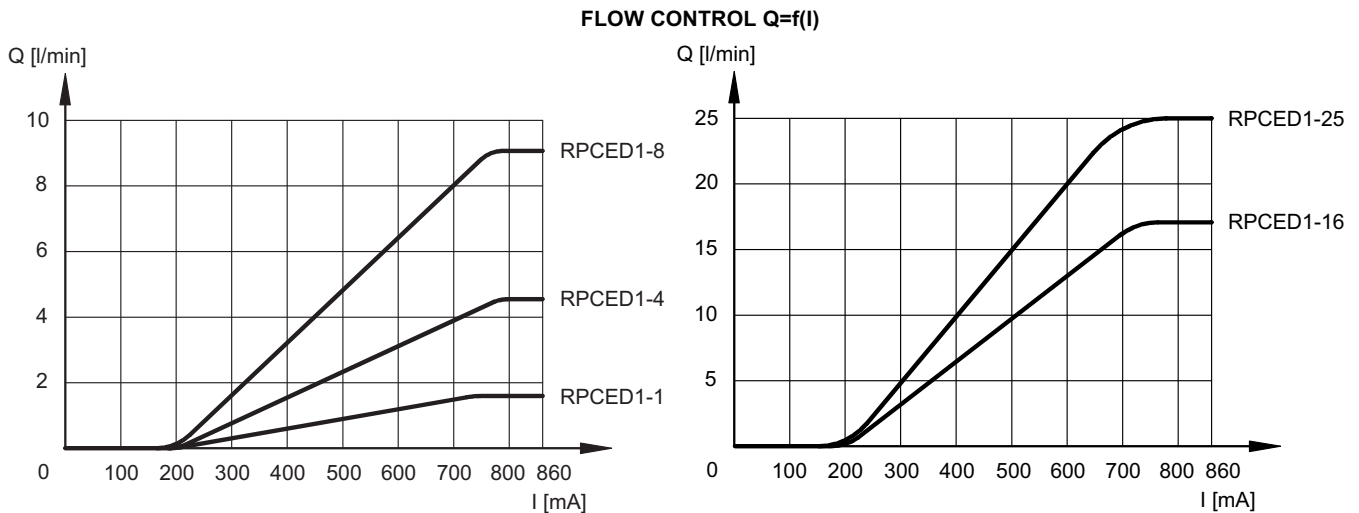

Pressure drop with free flow B → A through check valve.

3 - PRESSURE COMPENSATION

The valves are equipped with two restrictors in series. The first one is an opening which can be adjusted by the proportional solenoid; the second, controlled by the pressure upstream and downstream of the first restrictor ensures constant pressure drop across the adjustable restrictor. In these conditions, the set flow rate value is maintained constant within a tolerance limit of $\pm 2\%$ of the full scale flow rate for maximum pressure variation between the valve inlet and outlet chambers.

4 - THERMAL COMPENSATION

Thermal compensation of the valve is obtained by adopting the principle of restricted fluid passage, so that the fluid is not influenced significantly by variations in oil viscosity.

For controlled flow rates of lower than 0.5 l/min and with a temperature change of 30°C, flow rate varies by approx. 13% of the set value.

For higher flow rates and with the same temperature change the flow rate variation is <4% of the set flow rate.

5 - HYDRAULIC FLUIDS

Use mineral oil-based hydraulic fluids HL or HM type, according to ISO 6743-4. For these fluids, use NBR seals. For fluids HFDR type (phosphate esters) use FPM seals (code V). For the use of other kinds of fluid such as HFA, HFB, HFC, please consult our technical department. Using fluids at temperatures higher than 80 °C causes a faster degradation of the fluid and of the seals characteristics.

The fluid must be preserved in its physical and chemical characteristics.

6 - ELECTRICAL CHARACTERISTICS

6.1 - Proportional solenoid

The proportional solenoid comprises two parts: tube and coil.

The tube, screwed to the valve body, contains the armature which is designed to maintain friction to a minimum thereby reducing hysteresis.

The coil is mounted on the tube secured by means of a lock nut and can be rotated through 360° depending on installation clearances.

NOMINAL VOLTAGE	V DC	24
RESISTANCE (at 20°C)	Ω	17.6
MAXIMUM CURRENT	A	0.86
DUTY CYCLE		100%
ELECTROMAGNETIC COMPATIBILITY (EMC)	According to 2004/108/CE	
CLASS OF PROTECTION: Atmospheric agents (CEI EN 60529)	IP 65	

7 - STEP RESPONSE (obtained with mineral oil with viscosity of 36 cSt at 50°C and electronic control cards)

Step response is the time taken for the valve to reach 90% of the set pressure value following a step change of reference signal.

The table illustrates typical response times with valve flow rate of 16 l/min and with input pressure of 100 bar.

REFERENCE SIGNAL STEP	0 → 100%	100 → 0%	25→75%	75→25%
Step response [ms]	60	80	50	70

8 - INSTALLATION

RPCED1 valves can be installed in any position without impairing correct operation.

Ensure that there is no air in the hydraulic circuit.

Valves are fixed by means of screws or tie rods on a flat surface with planarity and roughness equal to or better than those indicated in the relative symbols. If minimum values are not observed fluid can easily leak between the valve and support surface.

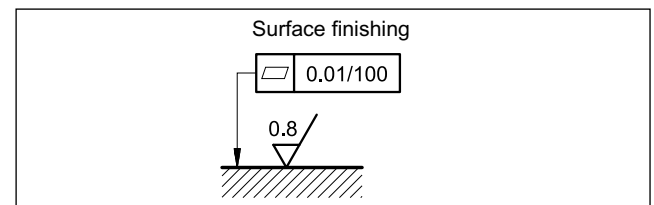

9 - OVERALL AND MOUNTING DIMENSIONS

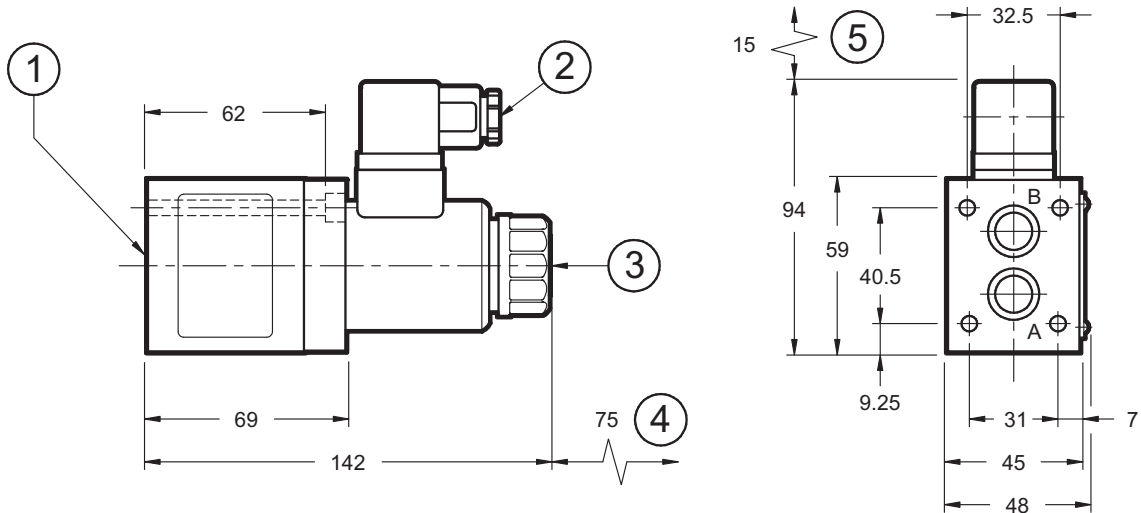

dimensions in mm

Fastening bolts: 4 bolts M5x70
Torque: 5 Nm

1	Mounting surface with sealing rings: 2 ORM-0140-20 (14x2)
2	Coil electrical connector DIN 43650
3	Manual emergency control
4	Coil removal space
5	Connector removal space

10 - ELECTRONIC CONTROL UNITS

EDC-112	for solenoid 24V DC	plug version	see cat.89 120
EDM-M111	for solenoid 24V DC	DIN EN 50022 rail mounting	see cat. 89 250

11 - SUBPLATES (see cat. 51 000)

Type	PMRPC1-AI3G ports on rear PMRPC1-AL3G side ports
Port dimensions	3/8" BSP