

The logo features the word 'ZEUS' in a bold, black, sans-serif font. The letter 'U' is replaced by a stylized purple icon that resembles a lightning bolt or a flame. To the right of 'ZEUS', the words 'HYDRATECH LTD' are written in a smaller, black, all-caps, sans-serif font. Below this, the tagline 'Global Suppliers of Premium Hydraulic Components' is written in a purple, italicized, sans-serif font. The background consists of large, overlapping, light purple and white curved shapes.

ZEUS HYDRATECH LTD
Global Suppliers of Premium Hydraulic Components

Official UK Distributor for Oilgear Hydraulic Components
T: +44(0)1172 130042. E: sales@zeushydratech.com. W: zeushydratech.com

AXIAL-PISTON HYDRAULIC PUMPS

PVG PUMPS

OPEN-LOOP, VARIABLE DISPLACEMENT

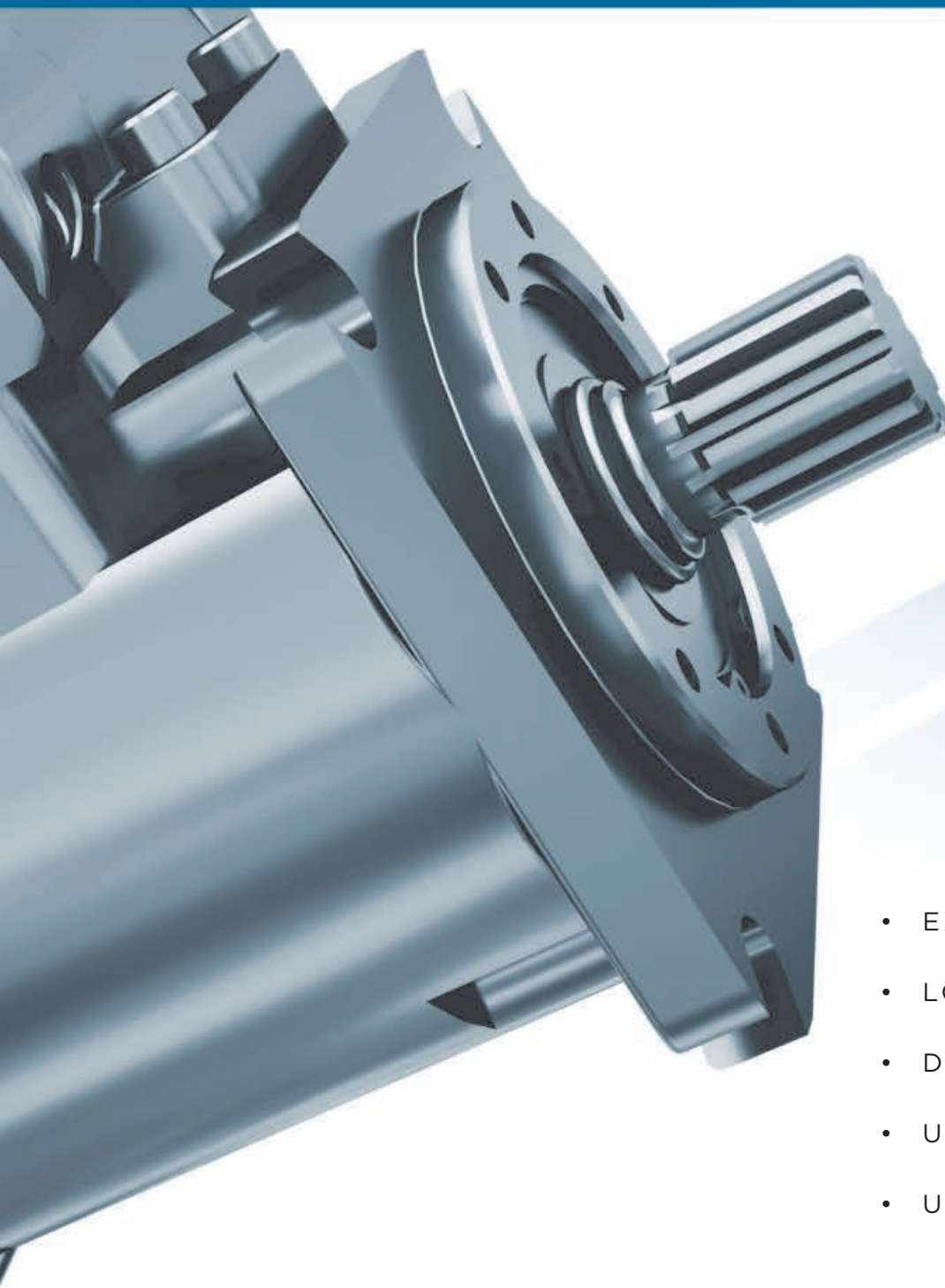

- EXTREMELY RESPONSIVE
- LOW VISCOSITY FLUIDS
- DIRT TOLERANT
- UP TO 400 BAR
- UP TO 396 LPM

OILGEAR
BEST UNDER PRESSURE

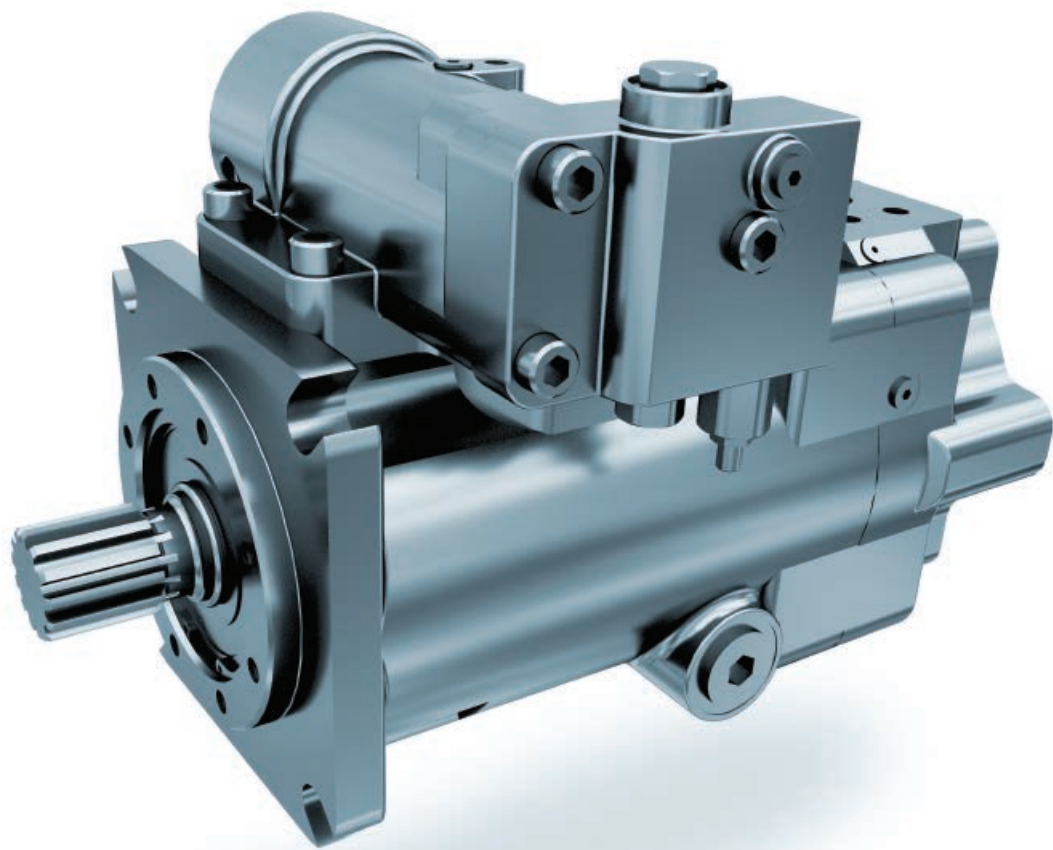

TABLE OF CONTENTS

Features and Benefits	2-3
Specifications	4
Shaft Torque Ratings	5
Pump Controls	6
Pressure Compensator	6
Dual Pressure Compensator	6
Soft Start Pressure Compensator	7
Load Sensing	7
Load Sense Plus	8
Horsepower Limiter	8
Horsepower Limiter w/Load Sensing Horsepower	9
Limiter w/Load Sense Plus Dual Pressure	9
Dual Compensator w/HP Limiter	10
Soft Start Pressure Compensator w/HP Limiter	10
Electronic Displacement Control (EDC)	11
Electronic Displacement Control (EDC) w/Load Sensing	11
Electronic Proportional Pressure Compensator Electronic	12
Servo Valve	12
Fixed Volume	12
Performance Data	13-16
Sound Data	17-19
Inlet Data	20-22
How to Order	23-26
Supporting Documents	27

Copyright 2018 ■ The Oilgear Company ■ All Rights Reserved

01

PVG OPEN LOOP PUMPS

Computer optimized, high pressure high volume pump, with Oilgear's time proven rotating group.

Four-way pilot operated control.

- Provides fast on and off stroke time.
- Maintains constant pressure over full volume range.
- Delivers high performance in a compact package.

SAE Heavy duty shaft.

- Allows high thru torque capability.
- Dual units can handle full pressure and volume.
- SAE keyed or SAE splined shaft.

Sealed front shaft bearings.

- Enables operation with low viscosity or other special fluids.

Patented pressure lubricated swashblock.

- Delivers high performance for high pressure high cycle operation.
- Pressure lubricated upper and lower saddle bearings provide for long life.

Hardened steel shoes with specially designed face for increased fluid retention, running on hardened swashblock surface.

- Provides a higher degree of contaminate resistance.
- Allows higher pressure operation.
- Enables operation with low viscosity or other special fluids.
- Provides long life at rated pressure.

Swashblock with polymeric bearings.

- Allows running on low viscosity or other special fluids.
- Permits constant control reaction with low hysteresis.
- Eliminates troublesome yoke bearings
- Provides long life.

Cylinder mounted polymeric journal bearings.

- Allows operation with low viscosity or other special fluids.
- Provides infinite bearing life.
- Enables compact design.

Rugged cylinder design.

- Hardened nodular iron construction for improved performance and contamination resistance.

Large control selection.

- Pressure and volume controls are available with a large variety of options.
- Field interchangeability without disconnecting from drive or system piping.

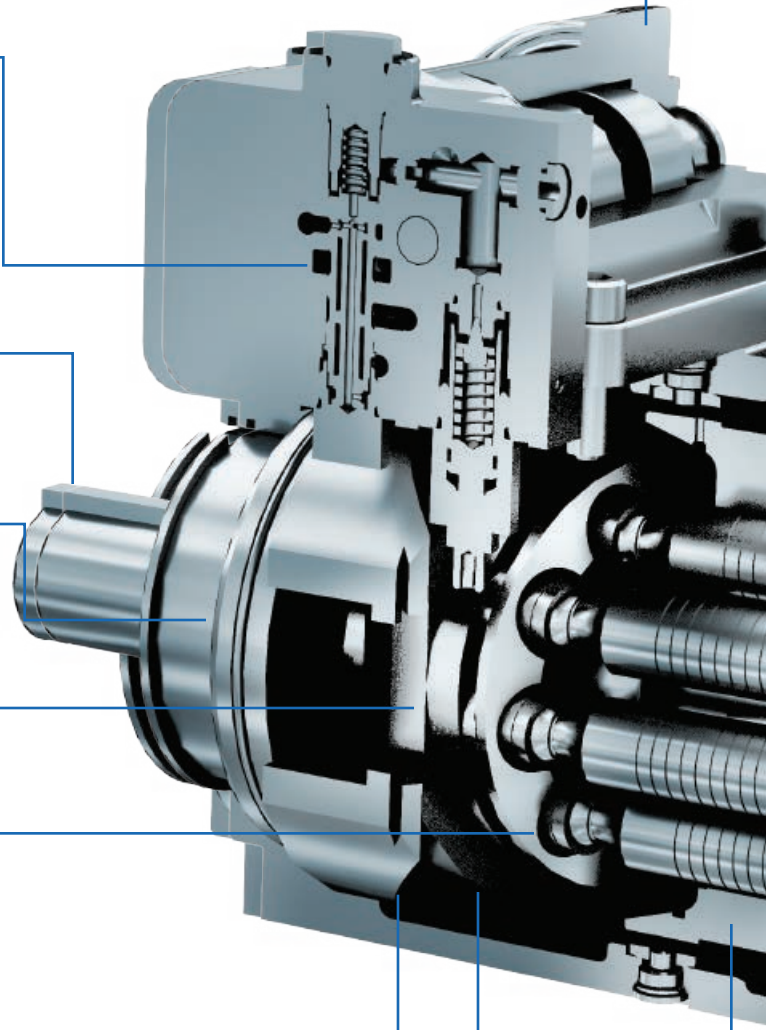

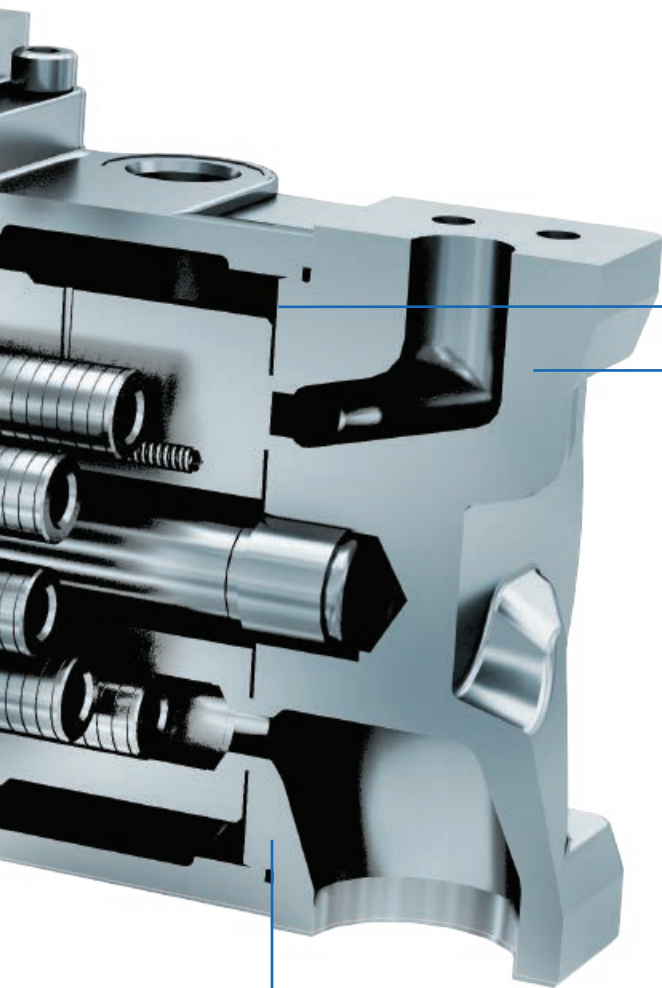

Hardened cylinder surface running on hardened valve plate "hard-on-hard".

- Provides greater resistance to contamination.
- Provides long life.
- Allows operation with low viscosity or other special fluids.

Valve plate selection.

- Top and bottom port connections available.
- Allows for multiple pump installation from a single drive shaft.
- Dual configuration with capability of full load on both pumps.
- Has provisions for mounting "AA" thru "D" sizes for rear pumps.
- Both 2 and 4 bolt SAE mounts available.

Quiet valve plate design.

- Minimizes noise at typical electric motor speeds.
- Hardened nodular iron construction for long life.

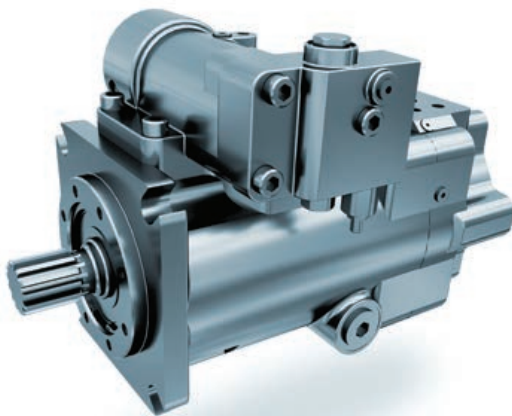



Nominal Performance Specifications

UNIT SIZE	THEORETICAL MAXIMUM DISPLACEMENT		RATED CONTINUOUS PRESSURE		PEAK PRESSURE		FLOW RATE at 1800 rpm, rated cont. pressure & 14.7 psia (bar abs) inlet conditions		MAXIMUM SPEED rpm	POWER INPUT at rated cont. pressure & 1800 rpm	
	in ³ /rev.	ml/rev.	psi	bar	psi	bar	gpm	l/min		hp	kw
048	2.93	48,0	5000	344,8	5800	400,0	21.1	79.9	2700	73	54.5
065	3.98	65,0	5000	344,8	5800	400,0	28.8	108.9	2700	100	74.6
075	4.60	75,4	3750	258,6	4250	293,1	33.3	126.0	2700	89	66.4
100	6.00	98,3	5000	344,8	5800	400,0	42.4	160.5	2400	150	111.9
130	7.94	130,2	3750	258,6	4250	293,1	57.6	218.0	2400	150	111.9
150	9.16	150,0	5000	344,8	5800	400,0	63.0	238.5	2400	215	160.4
180	10.98	180,0	5000	344,8	5800	400,0	78.0	295.3	2200	260	193.9

Nominal Dimensions

UNIT SIZE	LENGTH		WIDTH		HEIGHT		WEIGHT*		FACE MOUNTING
	in.	mm.	in.	mm.	in.	mm.	lbs.	kg.	
048, 065 & 075	12.0	303.9	6.9	174.5	6.3	160.4	68	31	SAE "B" 2 & 4 Bolt
100 & 130	13.0	330.5	8.4	212.9	7.3	185.7	115	52	SAE "C" 2 Bolt
150 & 180	14.2	360.7	7.9	200.7	8.1	205.7	171	78	SAE "D" 4 Bolt

All dimensions (without controls) are approximate. For detailed dimensions, contact your Oilgear Representative.

* Weights are with P-1 control. 048, 065, 075, 100 & 130 models are with rear ported valve plate.

150 & 180 models are with side ported valve plate.

PVG 048/065/075

3500 IN-LB = MAXIMUM ALLOWABLE TORQUE APPLIED TO REAR OUTPUT

MODEL CODE DESIGNATOR	SHAFT SIZE	ALLOWABLE INPUT TORQUE IN-LB
"Y"	1.00" KEY LONG	3,500
"S"	SPLINE 15 TOOTH 16/32 DP	7,000
"K"	SPLINE 13 TOOTH 16/32 DP	3,500
"R"	SPLINE 14 TOOTH 12/24 DP	7,000
"B"	1.25" KEY LONG	6,400

PVG 100/130

5250 IN-LB = MAXIMUM ALLOWABLE TORQUE APPLIED TO REAR OUTPUT

MODEL CODE DESIGNATOR	SHAFT SIZE	ALLOWABLE INPUT TORQUE IN-LB
"Y"	1.50" KEY LONG	10,500
"Z"	1.50" KEY SHORT	6,000
"S"	SPLINE 17 TOOTH 12/24 DP	10,500
"K"	SPLINE 14 TOOTH 12/24 DP	7,000
"R"	SPLINE 13 TOOTH 8/16 DP	10,500

PVG 150/180

7500 IN-LB = MAXIMUM ALLOWABLE TORQUE APPLIED TO REAR OUTPUT

MODEL CODE DESIGNATOR	SHAFT SIZE	ALLOWABLE INPUT TORQUE IN-LB
"Y"	1.75" KEYED	15,000
"L"	SPLINE 13 TOOTH 8/16 DP	15,000

Pressure Compensator "P-1"

Ensures maximum pump flow until unit reaches preset control pressure setting then regulates output flow to match the requirements of the system while maintaining preset output pressure.

Can be adjusted from 200 psi (250 psi for PVG 150 & PVG 180) working pressure up to the maximum pressure rating of pump.

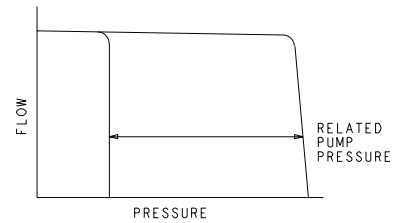
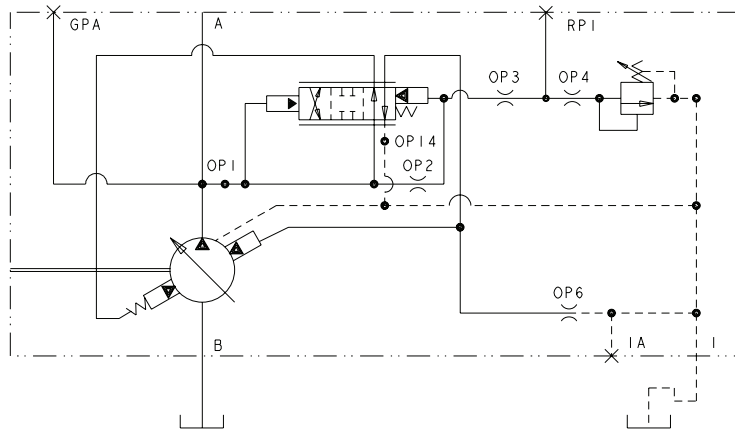

Dual Pressure Compensator "P-2"

Provides two independently adjustable pressure compensated settings as selected by an integral solenoid.

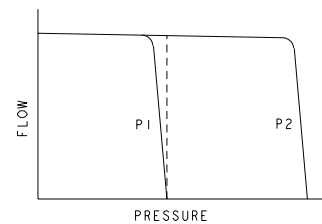
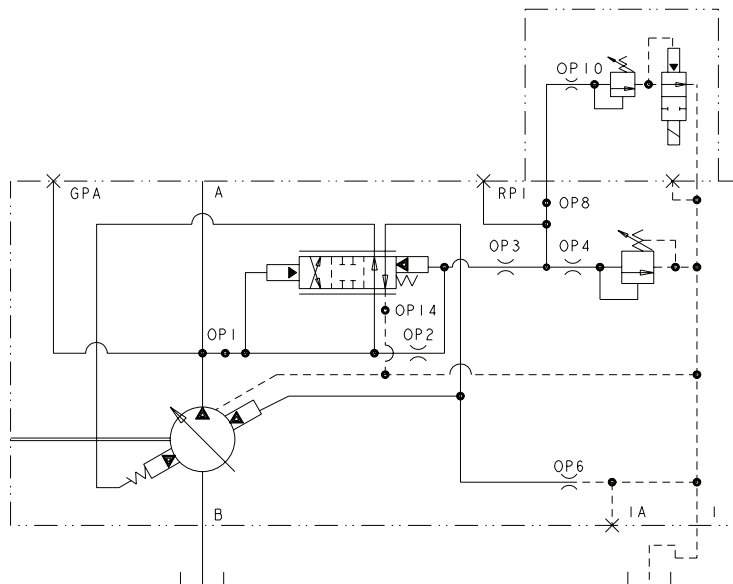

Soft Start Pressure Compensator "P-C"

Pump starts "softly" by going quickly at low pressure to a reduced flow setting, thereby reducing start up torque requirements.

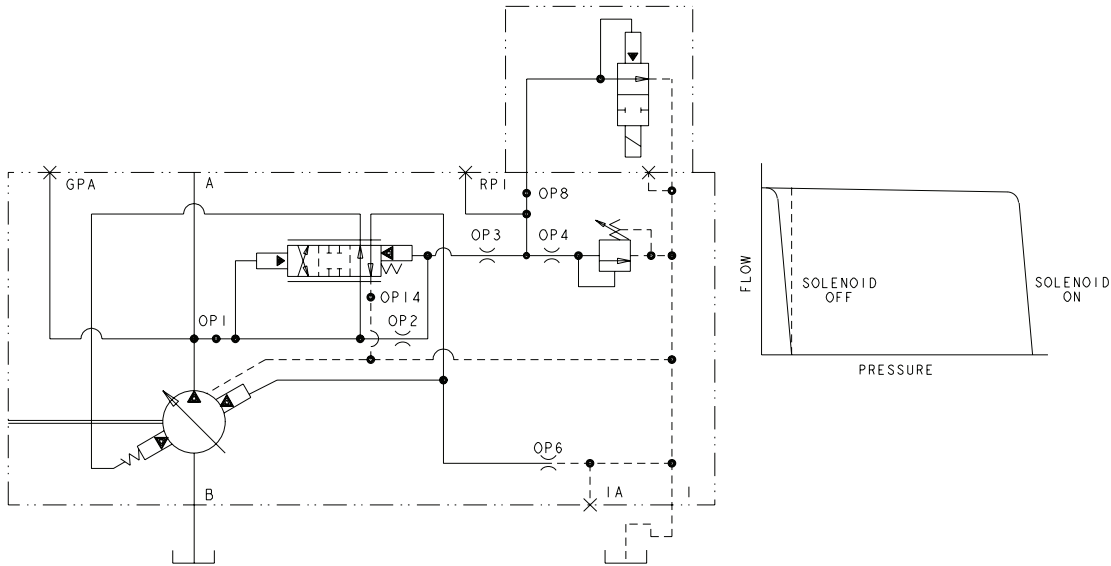

Load Sensing "P-1/F"

A constant flow output is maintained for a given flow control valve setting regardless of changes in drive speed and/or working pressure.

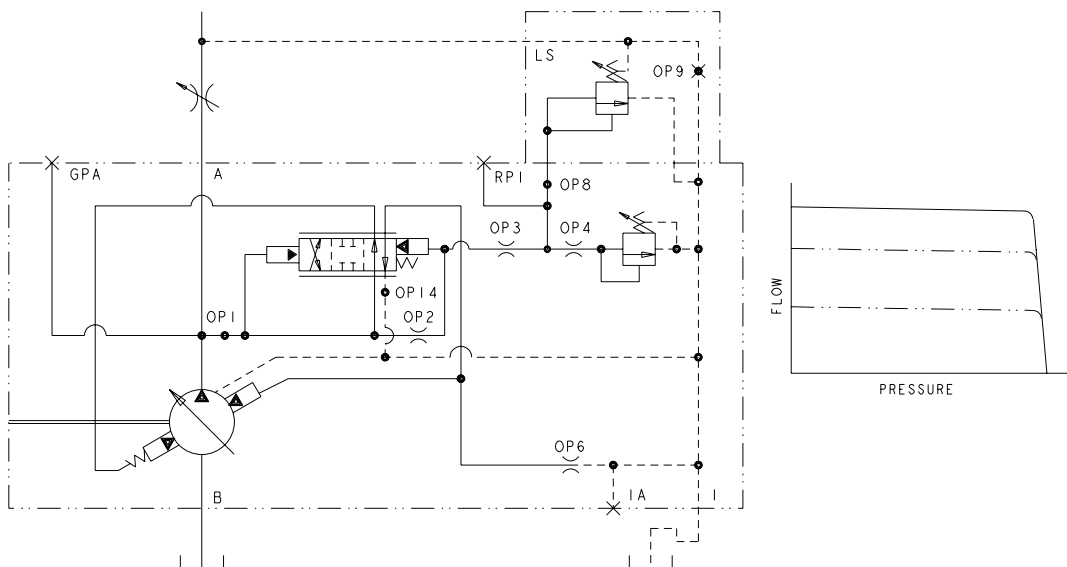

Load Sense Plus "P-1/K"

A constant flow output is maintained for a given flow control valve setting regardless of changes in drive speed and/or working pressure. The Load Sense Plus control enables the user to externally adjust the minimum pressure setting without affecting the load sense differential.

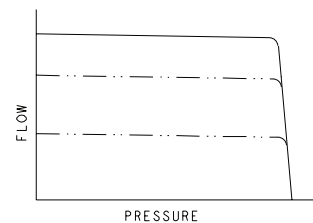
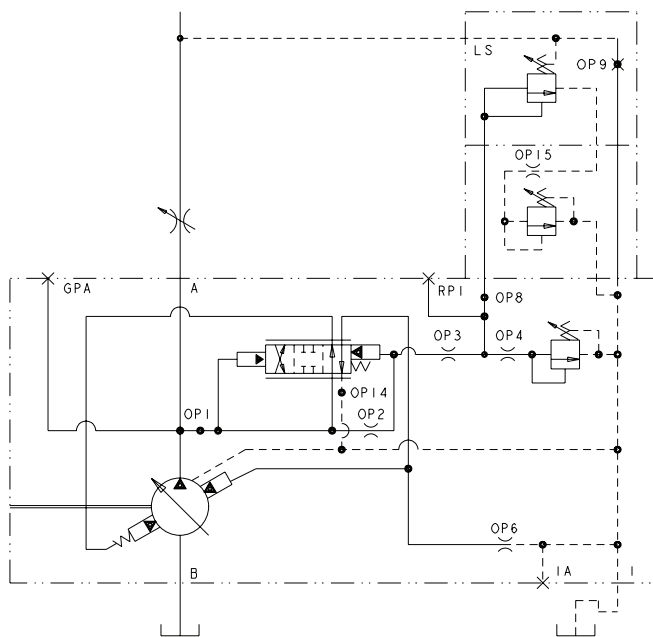

Horsepower Limiter "P-1/H"

Automatically reduces delivery, as unit pressure rises, to limit horsepower consumption.

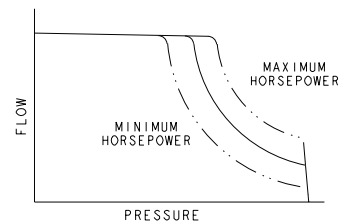
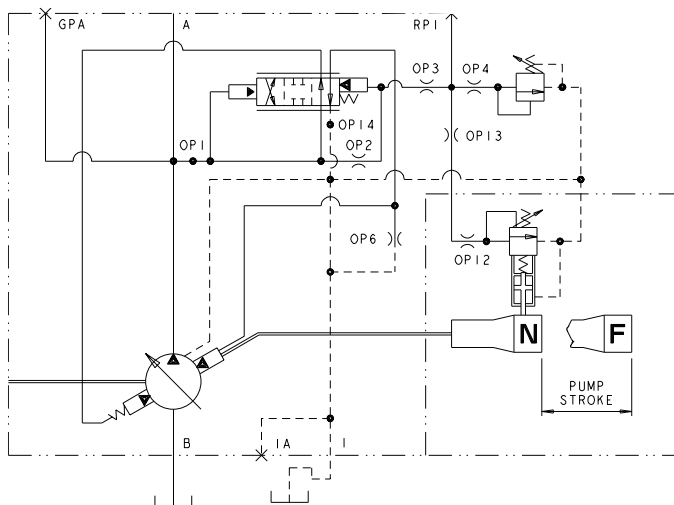

MODEL	MINIMUM HORSEPOWER	MAXIMUM HORSEPOWER	MINIMUM HORSEPOWER TO OBTAIN FLOW AT RATED PRESSURE
-048	20	80	25
-065	20	80	25
-075	20	80	20
-100	18	125	35
-130	18	125	35
-150	50	190	50
-180	50	190	50

ALL HORSEPOWER VALUES ARE FOR 1800 RPM.

Horsepower Limiter w/Load Sensing “P-1/G”

Load sensing control matches flow and pressure to load demand until (limited) horsepower setting is reached. Control then automatically reduces delivery as system pressure rises.

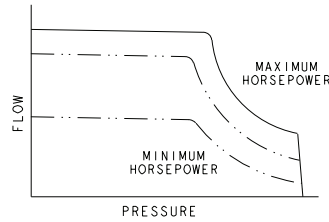
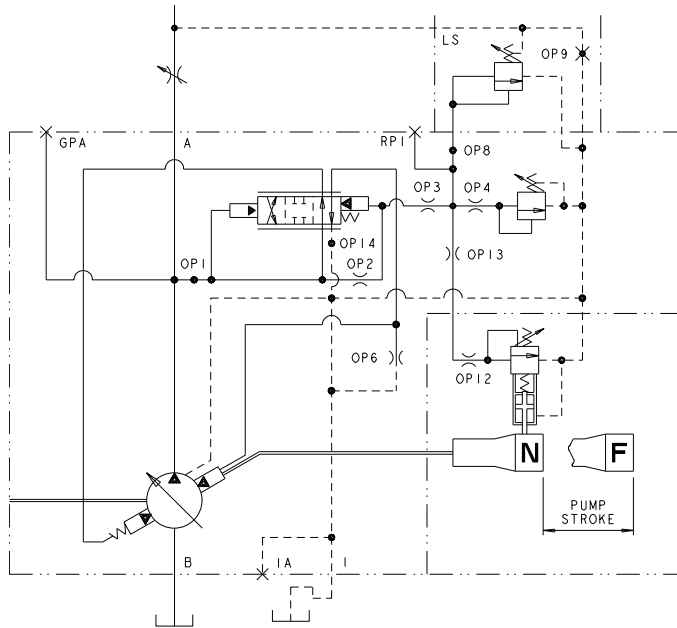

MODEL	MINIMUM HORSEPOWER	MAXIMUM HORSEPOWER	MINIMUM HORSEPOWER TO OBTAIN FLOW AT RATED PRESSURE
-048	20	80	25
-065	20	80	25
-075	20	80	20
-100	18	125	35
-130	18	125	35
-150	50	190	50
-180	50	190	50

ALL HORSEPOWER VALUES ARE FOR 1800 RPM.

Horsepower Limiter w/Load Sense Plus “P-1/L”

Load sensing control matches flow and pressure to load demand until (limited) horsepower setting is reached. Control then automatically reduces delivery as system pressure rises. The Load Sense Plus control enables the user to externally adjust the minimum pressure setting without affecting the load sense differential.

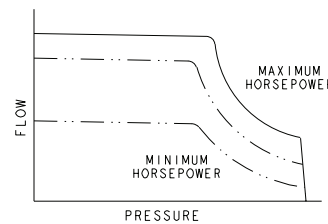
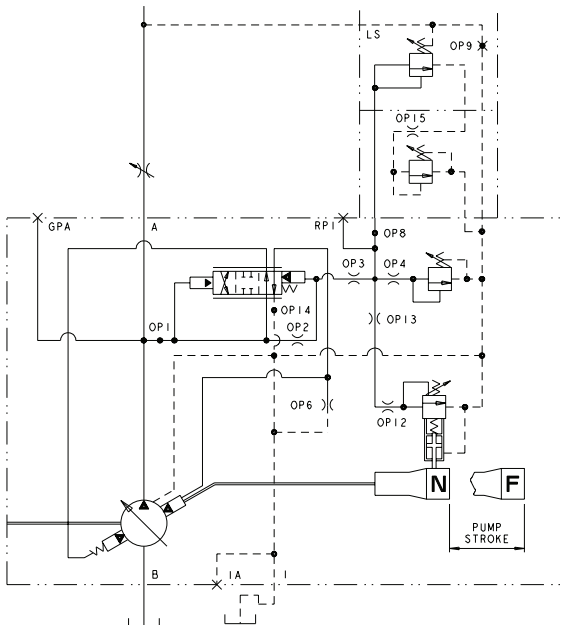

MODEL	MINIMUM HORSEPOWER	MAXIMUM HORSEPOWER	MINIMUM HORSEPOWER TO OBTAIN FLOW AT RATED PRESSURE
-048	20	80	25
-065	20	80	25
-075	20	80	20
-100	18	125	35
-130	18	125	35
-150	50	190	50
-180	50	190	50

ALL HORSEPOWER VALUES ARE FOR 1800 RPM.

Dual Pressure Compensator w/Horsepower Limiter "P-2/H"

Provides two independently adjustable pressure compensated settings as selected by an integral solenoid. Automatically reduces delivery, as unit pressure rises, to limit horsepower consumption.

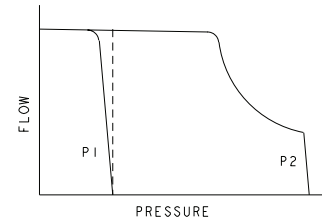
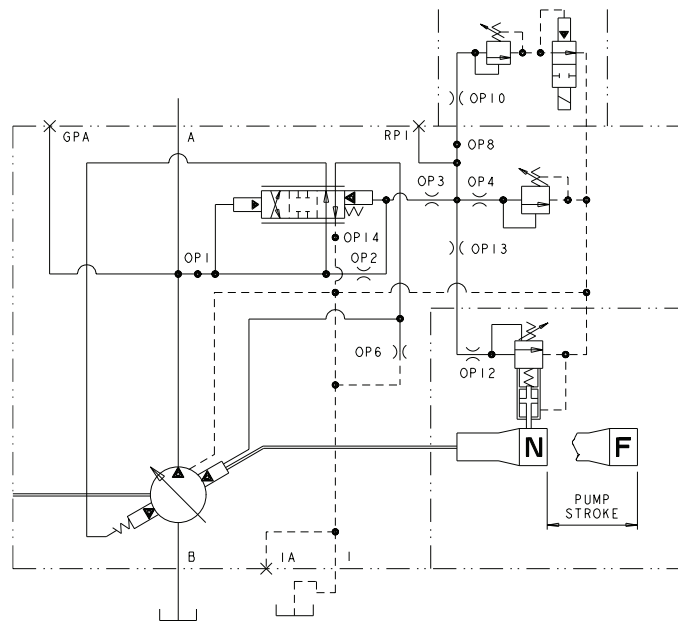

MODEL	MINIMUM HORSEPOWER	MAXIMUM HORSEPOWER	MINIMUM HORSEPOWER TO OBTAIN FLOW AT RATED PRESSURE
-048	20	80	25
-065	20	80	25
-075	20	80	20
-100	18	125	35
-130	18	125	35
-150	50	190	50
-180	50	190	50

ALL HORSEPOWER VALUES ARE FOR 1800 RPM.

Soft Start Pressure Compensator w/Horsepower Limiter "P-C/H"

Pump starts "softly" by going quickly at low pressure to a reduced flow setting, thereby reducing start up torque requirements. Automatically reduces delivery, as unit pressure rises, to limit horsepower consumption.

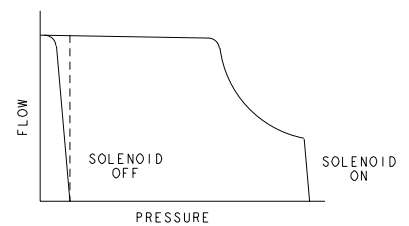
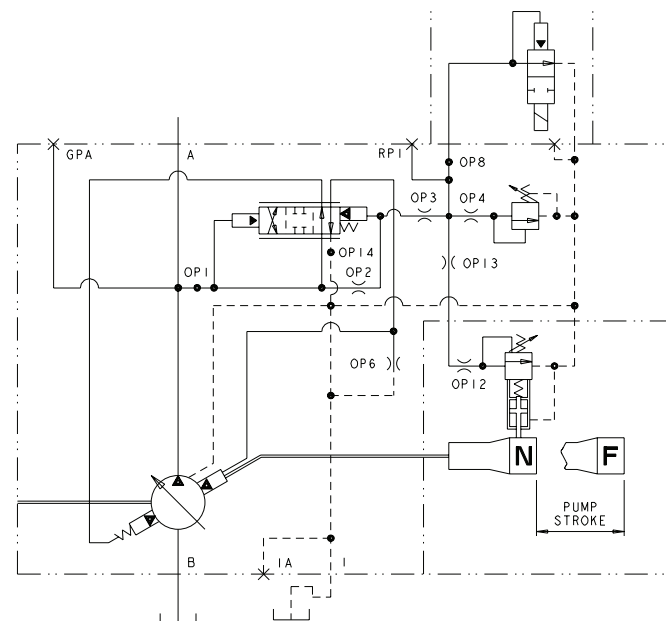

MODEL	MINIMUM HORSEPOWER	MAXIMUM HORSEPOWER	MINIMUM HORSEPOWER TO OBTAIN FLOW AT RATED PRESSURE
-048	20	80	25
-065	20	80	25
-075	20	80	20
-100	18	125	35
-130	18	125	35
-150	50	190	50
-180	50	190	50

ALL HORSEPOWER VALUES ARE FOR 1800 RPM.



Electronic Displacement Control (EDC) “P-E”

Pump displacement is linearly proportional to an electrical input. An increase in coil current will decrease pump displacement. Pressure compensator control overrides the EDC when preset control pressure setting is reached, then regulates output flow to match the requirements of the system while maintaining preset output pressure.

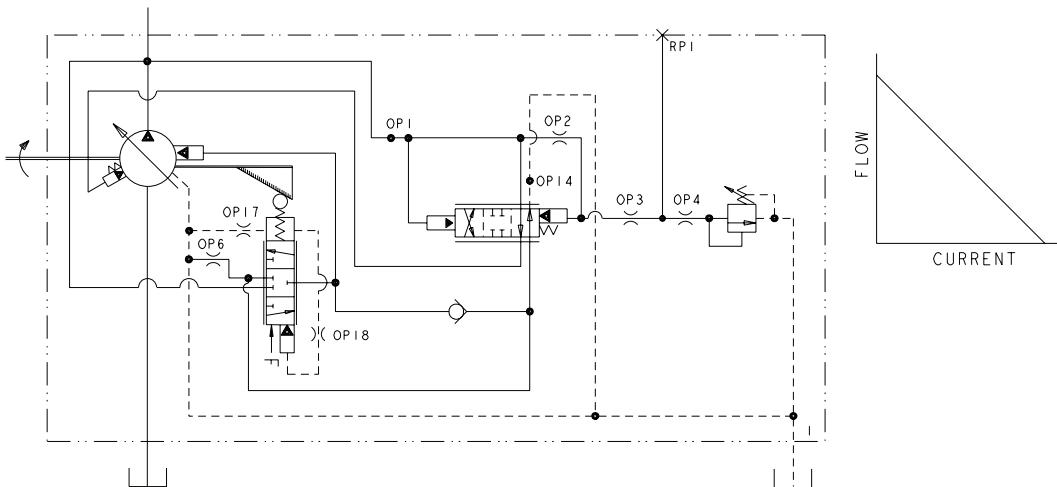

Electronic Displacement Control (EDC) w/Load Sensing “P-E/F”

Pump displacement is linearly proportional to an electrical input. An increase in coil current will decrease pump displacement. Load sensing control overrides the EDC and a constant flow output is maintained for a given flow control valve setting regardless of changes in drive speed and/or working pressure. Pressure compensator control overrides the EDC when preset control pressure setting is reached, then regulates output flow to match the requirements of the system while maintaining preset output pressure.

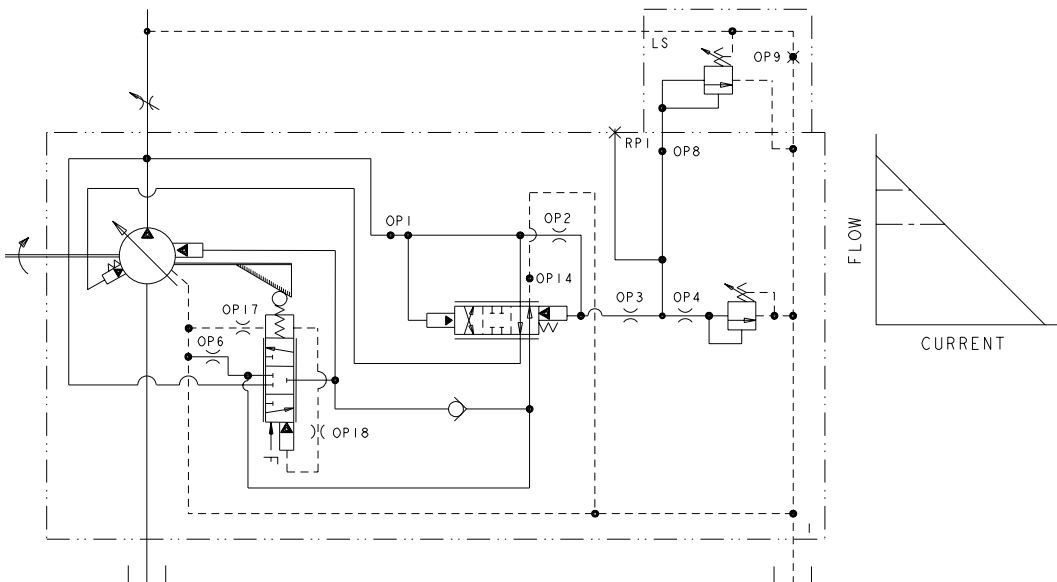

Electronic Proportional Pressure Compensator "P-A" (N.O.) "P-B" (N.C.)

Provides an infinite number of independent remotely adjustable pressure settings in response to an electrical command. (P-A shown)

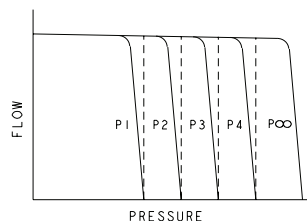
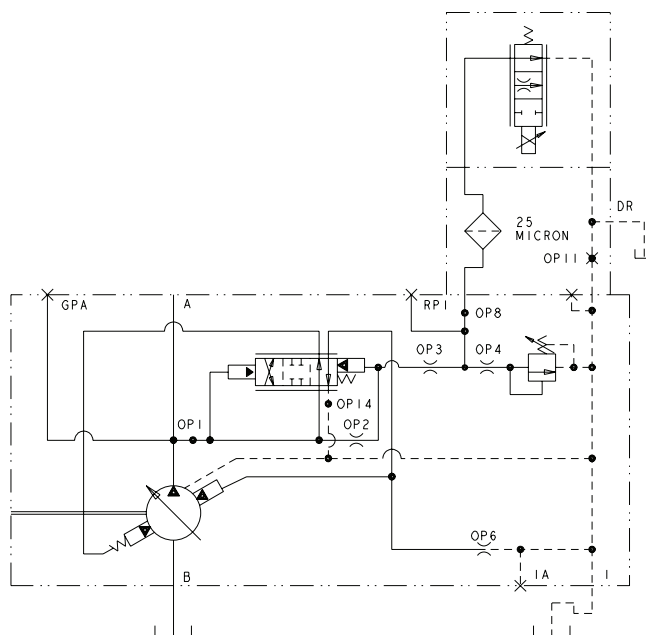

Electronic Servo Valve "V-M" "V-S"

An electrohydraulic servo valve positions the swashplate mechanism with a closed-loop position control (with LVDT feedback).

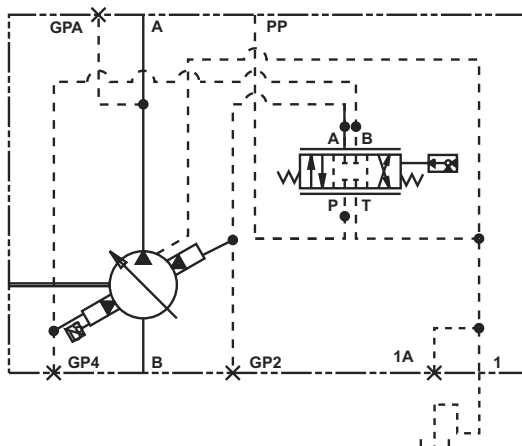

Fixed Volume "F"

Fixed displacement units available with stroke setting of three quarters and full volume.

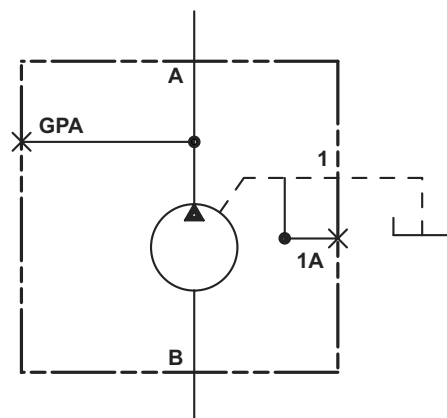

PVG-048

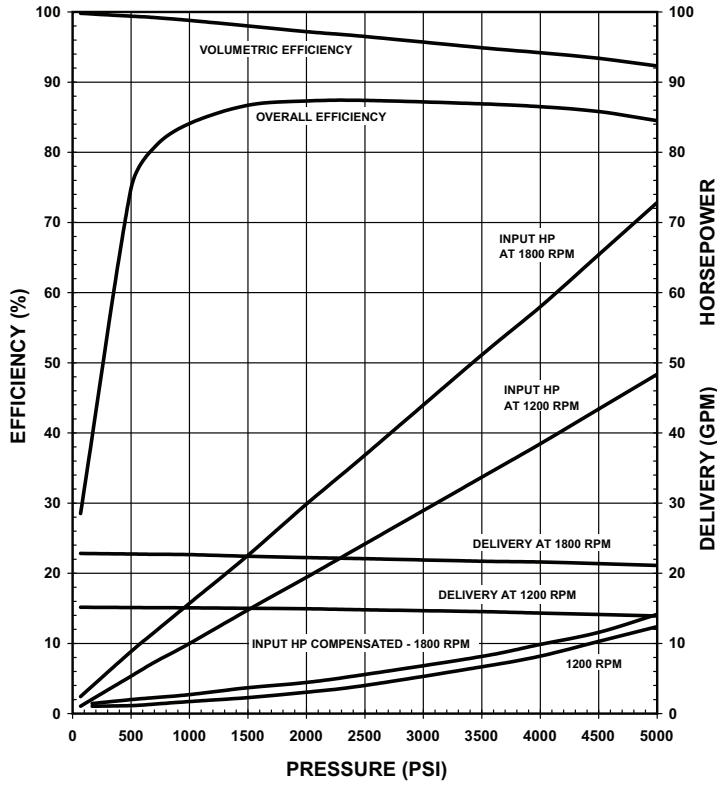

PVG-065

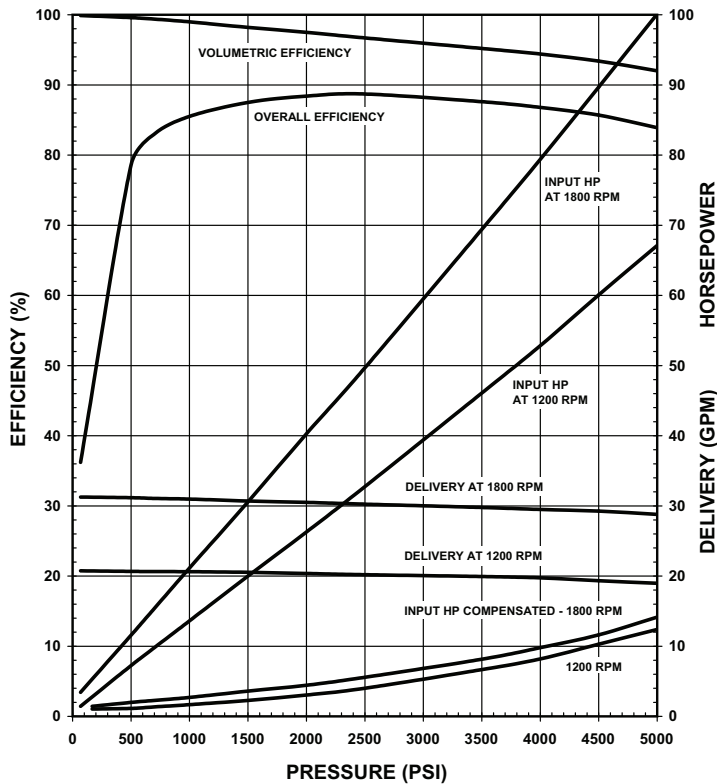



PVG-075

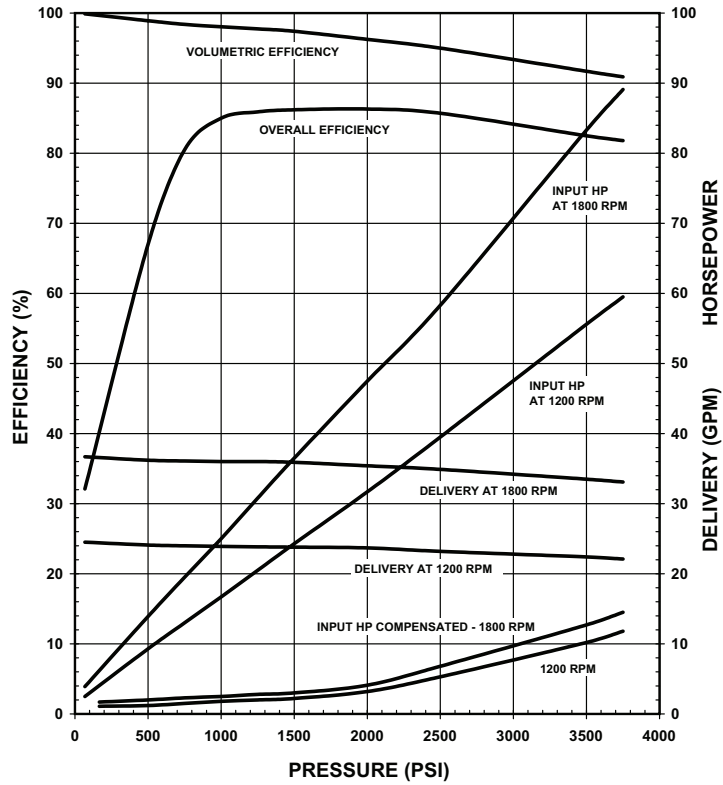

PVG-100

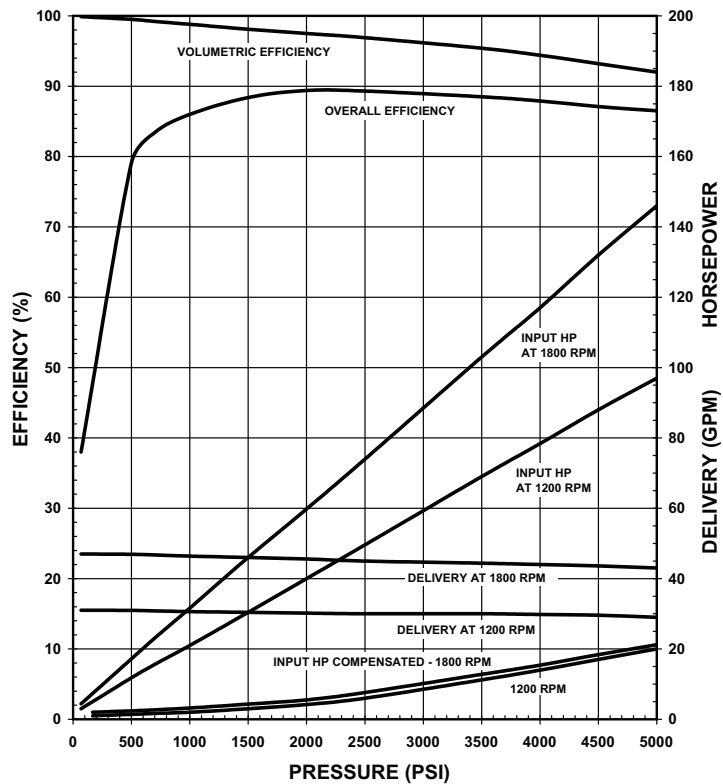

■ PVG-130

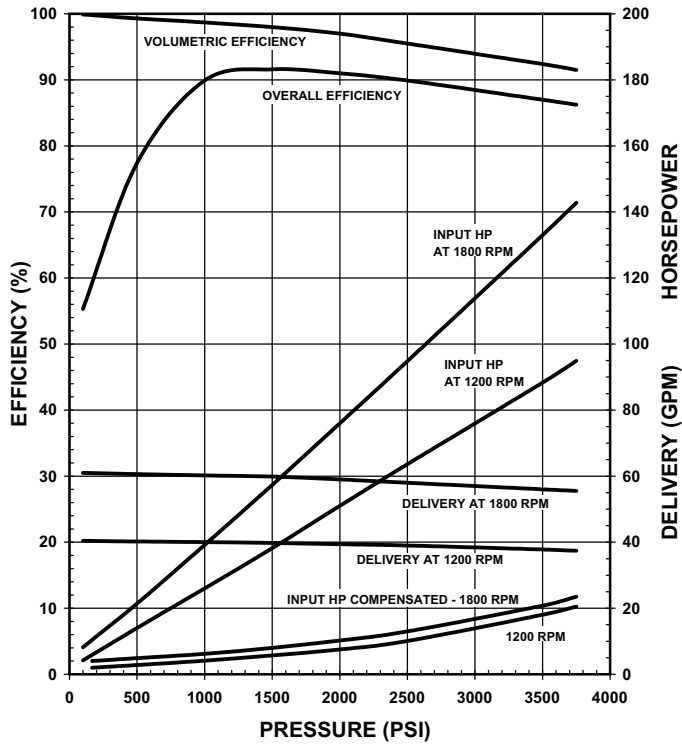

■ PVG-150

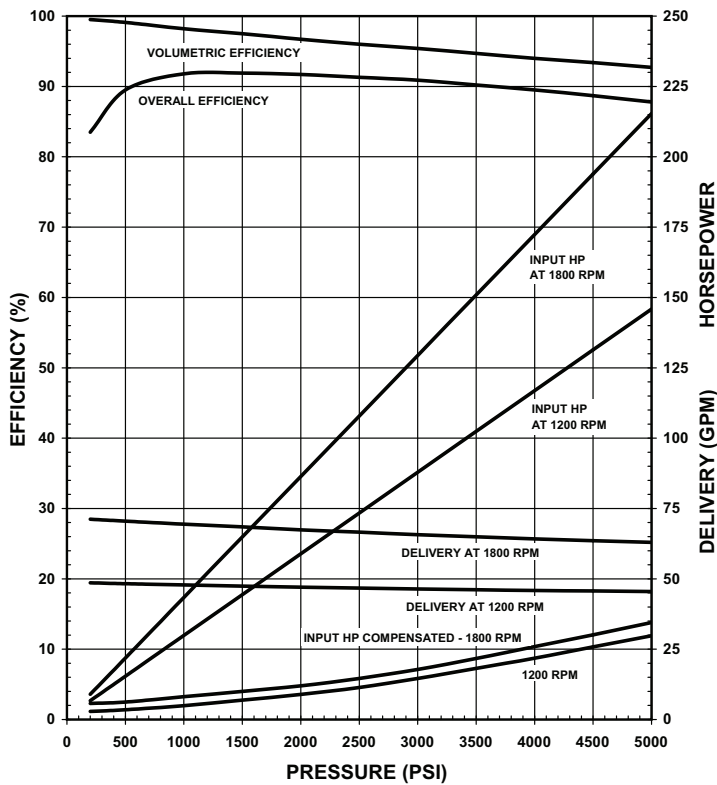



■ PVG-180

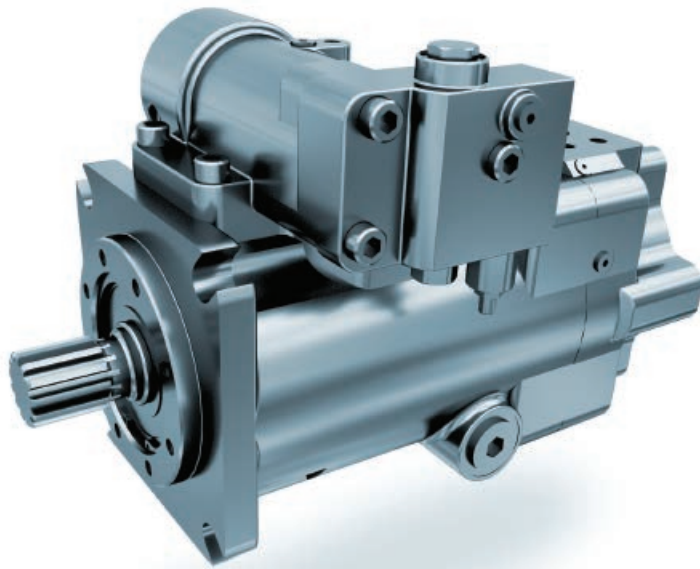
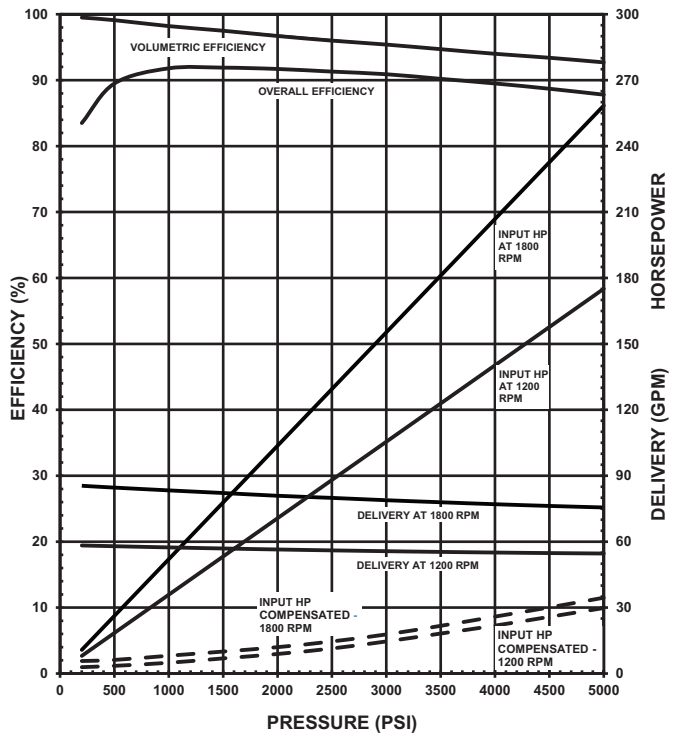

PERFORMANCE DATA

16



PVG-048

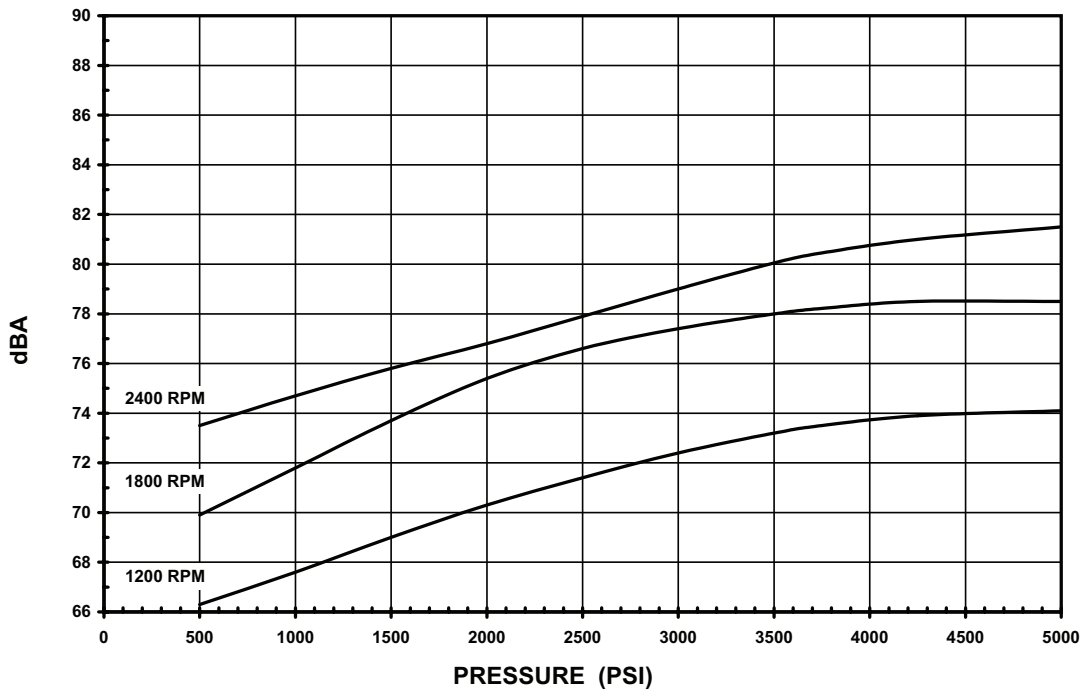

PVG-065

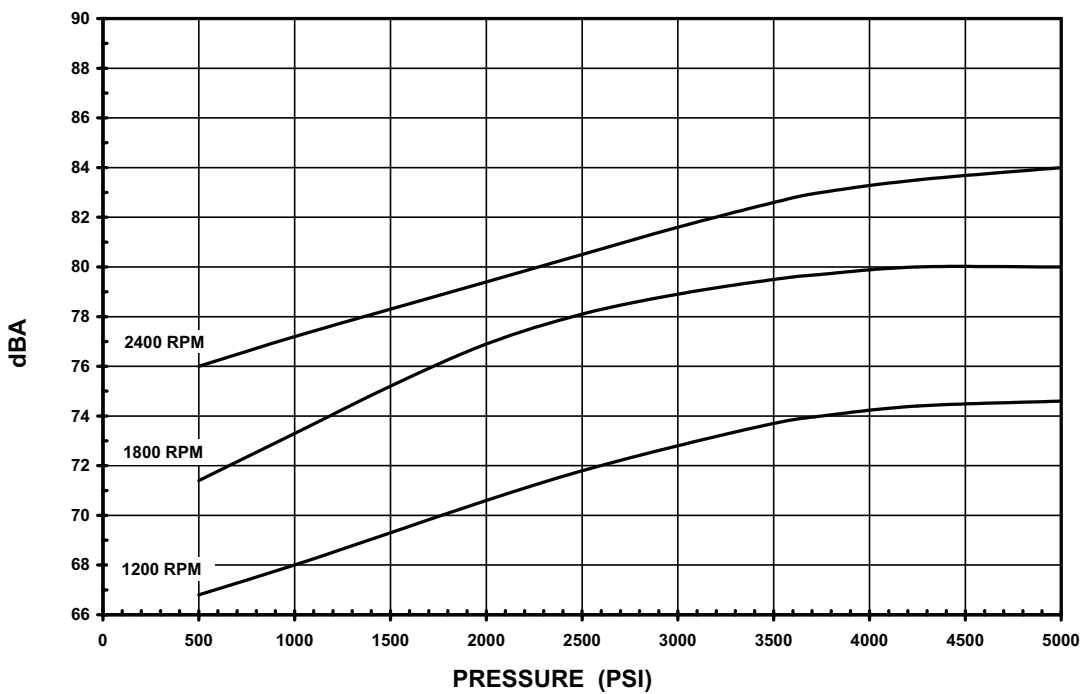



■ PVG-075

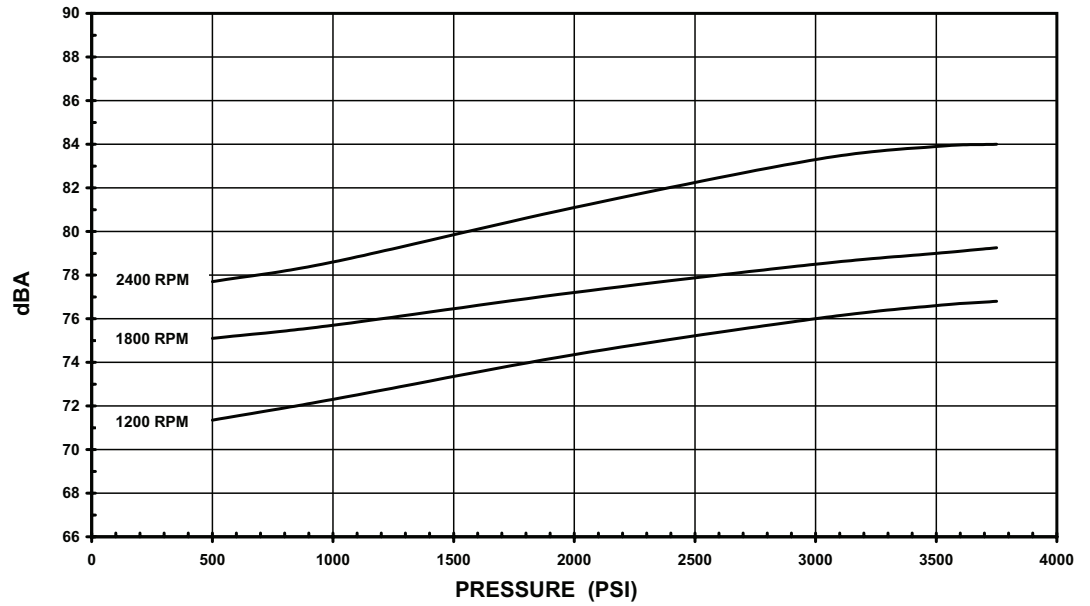

■ PVG-100

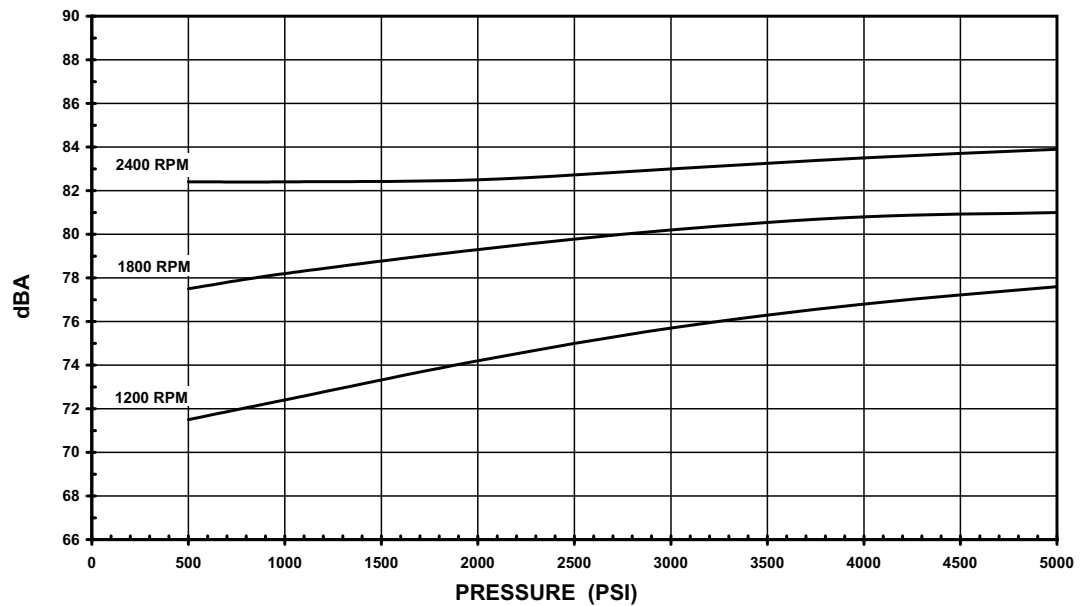

PVG-130

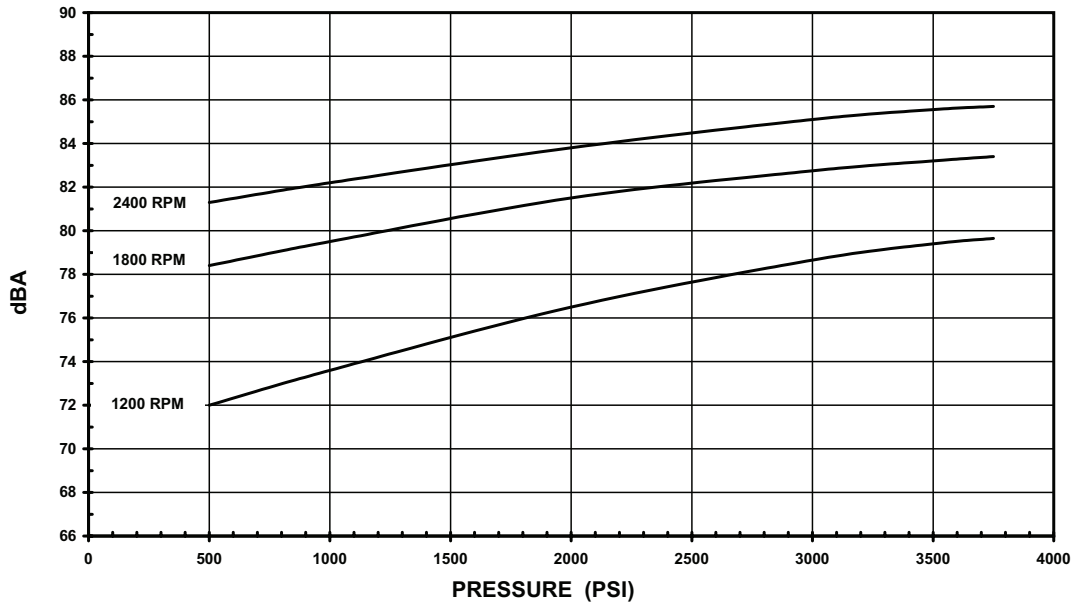

PVG-150

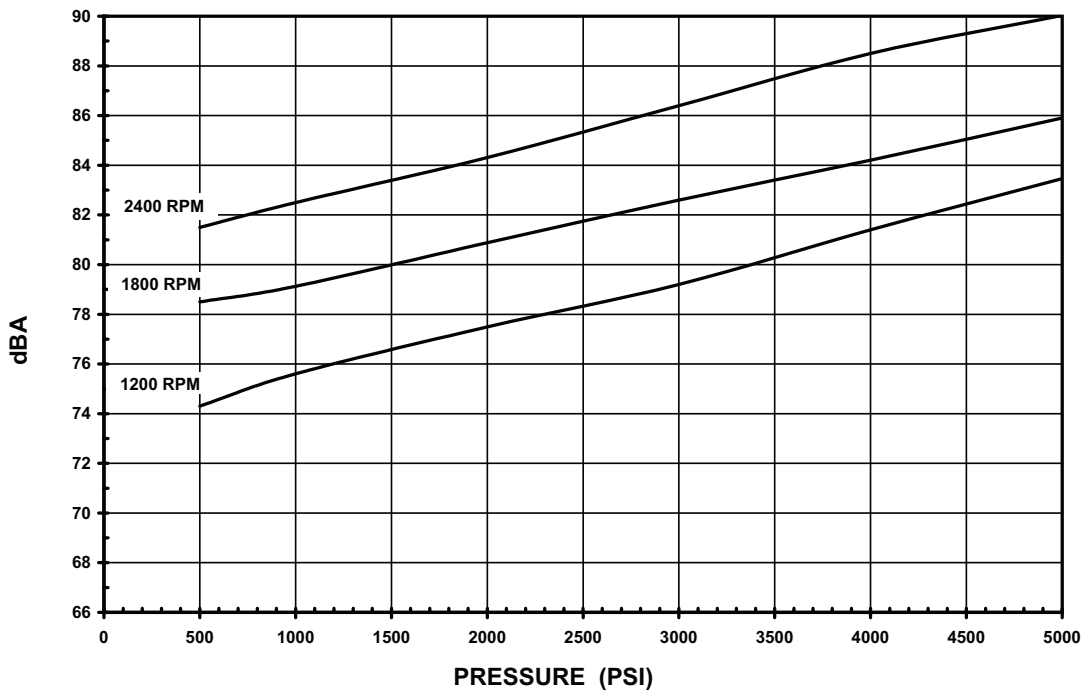



■ PVG-048

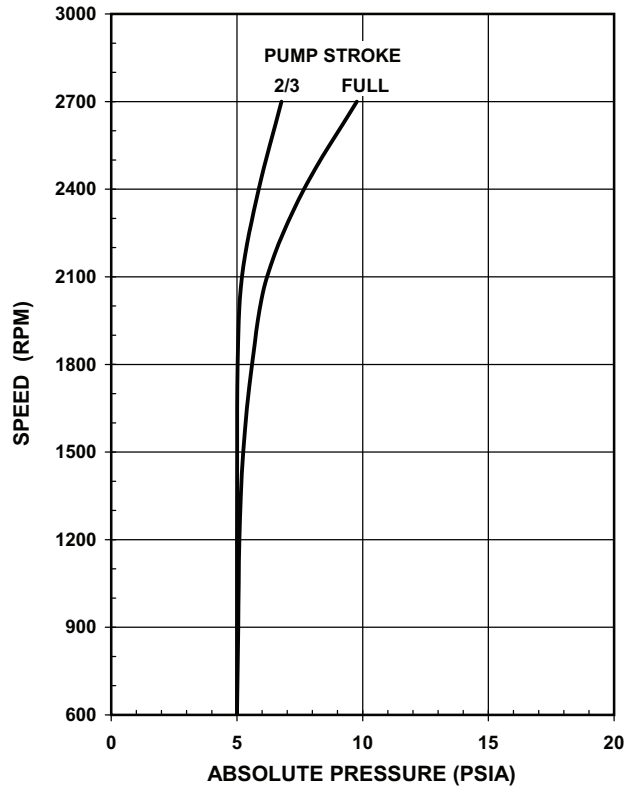

■ PVG-065

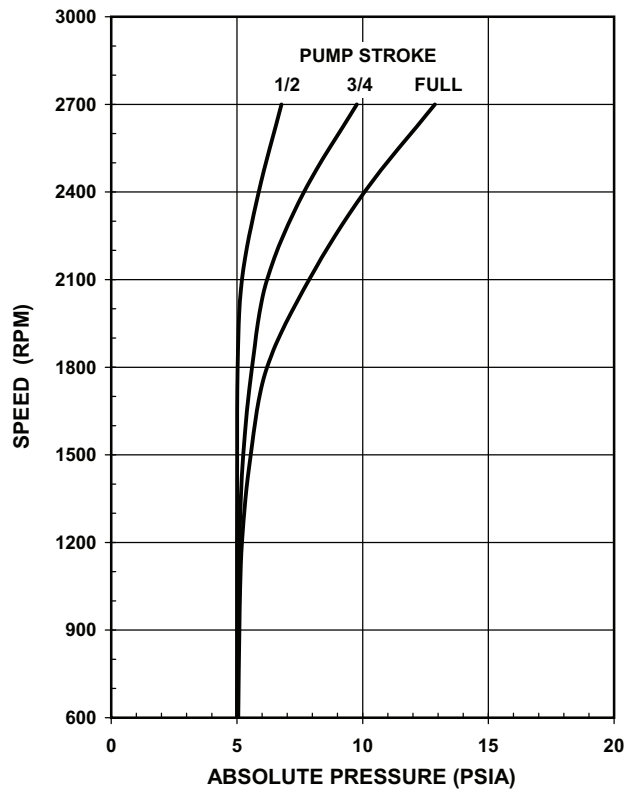

■ PVG-075

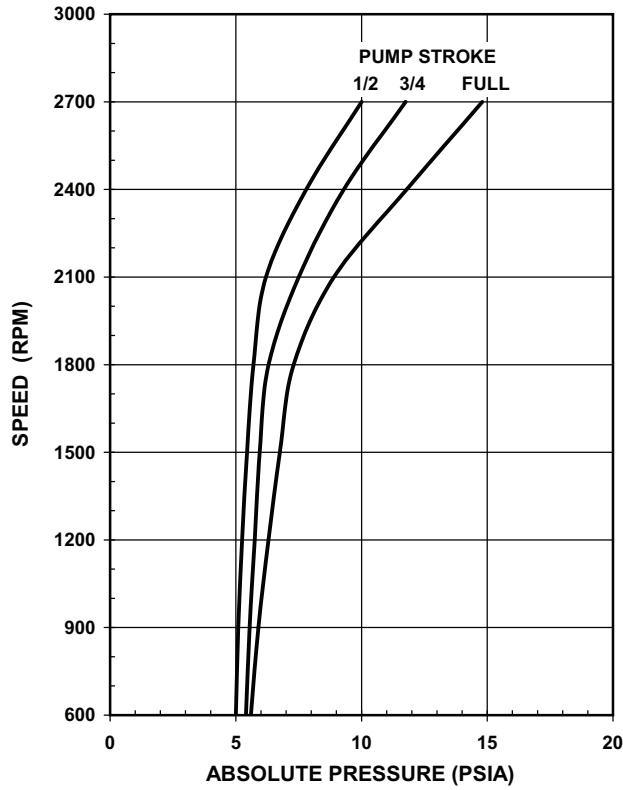

■ PVG-100

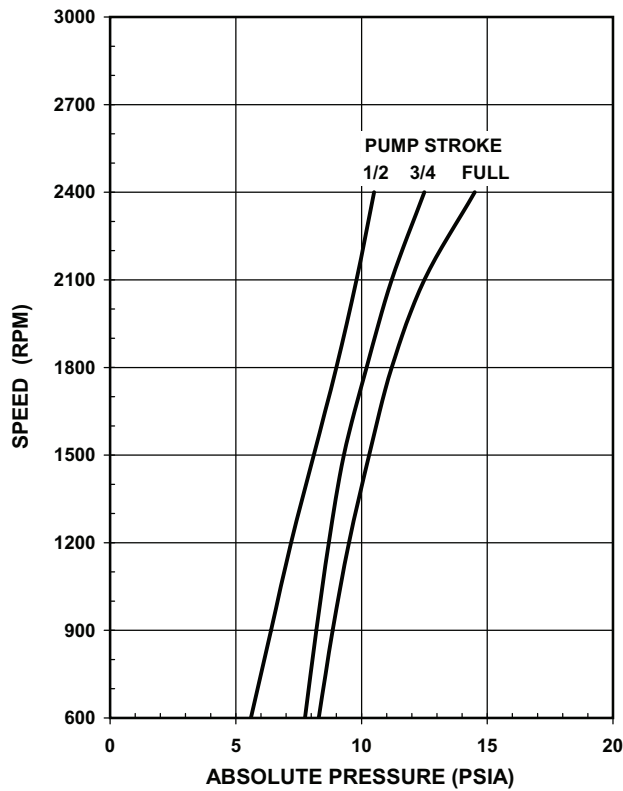



■ PVG-130

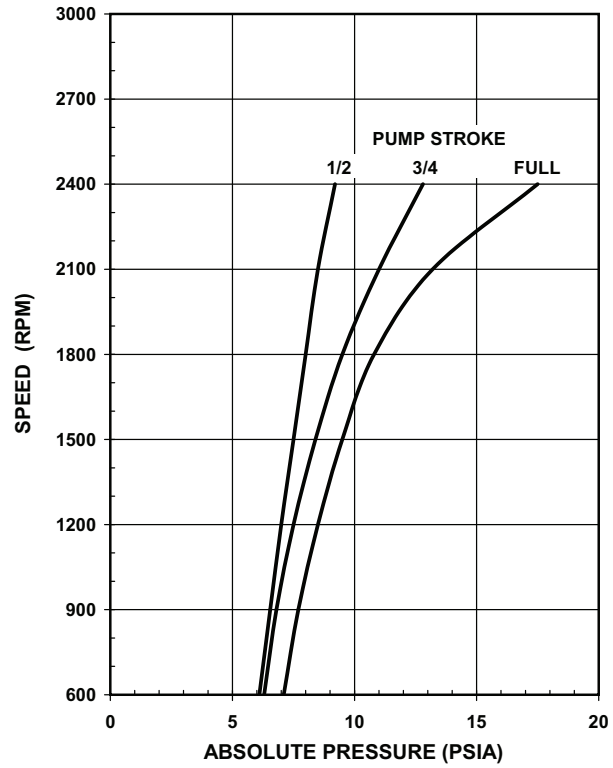

■ PVG-150

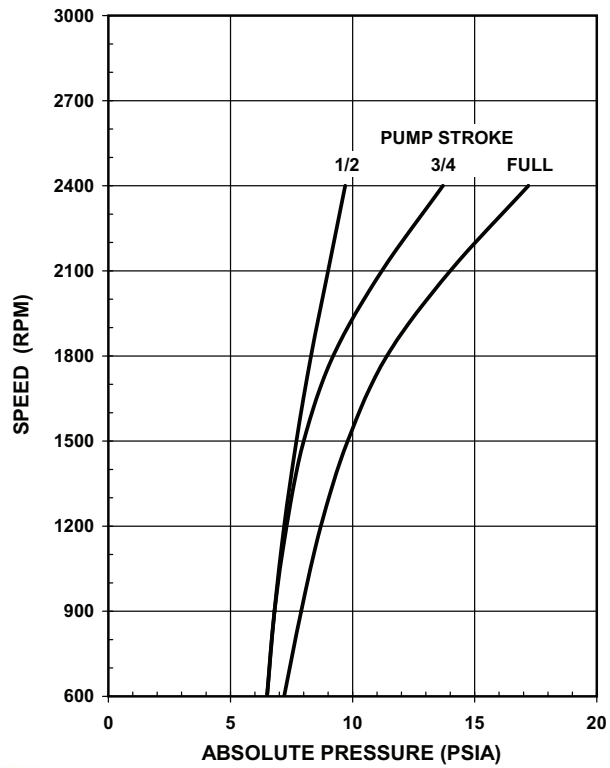

■ PVG-180

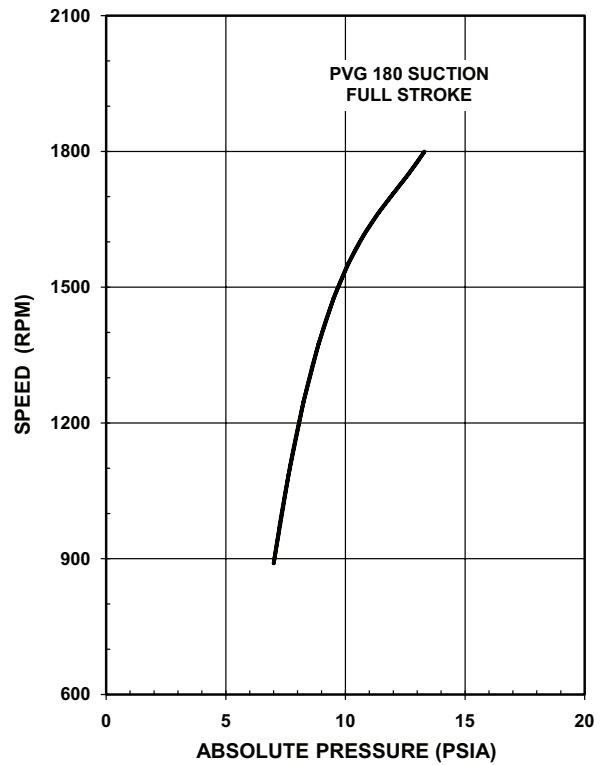

HOW TO ORDER - PVG 048, 065, 075

BLOCK NUMBER EXPLANATION	1	2	3	-	4	-	5	6	7	-	8	9	10	11	-	12	-	13	14	-	15	/	16	-	17
VARIABLE PUMP EXAMPLE	P	V	G	-	075	-	F1	U	V	-	L	D	F	Y	-	P	-	1NN	SN	-	AN	/	05	-	-

- 1 = UNIT**
P = Pump
- 2 = TYPE**
V = Variable
- 3 = DESIGN SERIES**
G = Type
- 4 = UNIT SIZE**
048 = 48 ml/rev. (2.93 cipr)
065 = 65 ml/rev. (3.96 cipr)
075 = 75 ml/rev. (4.60 cipr)
- 5 = DESIGN SERIES**
F1 = Current
- 6 = DESIGN SERIES MODIFIER**
U = SAE Connections & Mounting
- 7 = SEALS**
V = Viton (Standard)
B = Buna Nitrile
P = EPR
- 8 = ROTATION**
L = Left Hand (CCW)
R = Right Hand (CW)
- 9 = VALVE PLATE TYPE**
G = Side Ported
D = Side Ported (thru-shaft)
S = Rear Ported
- 10 = CONNECTION TYPE**
F = Flange
- 11 = INPUT SHAFT TYPE**
Y = 25-1 (SAE B-B Keyed)
S = 25-4 (SAE B-B Spline)
K = 22-4 (SAE B Spline)
B = 32-1 (SAE C Keyed)
R = 32-4 (SAE C Spline)
- 12 = CONTROL TYPE**
N = None
F = Fixed
P = Pressure Compensating
R = Solenoid Operated Volume
V = Electrohydraulic
(with feedback)

13 = CONTROL MODIFIER

13					
a	b	c	/	d	e

- For Control Type "F":**
- 13a, b, c CONTROL OPTIONS**
075 = 75% Stroke
100 = 100% Stroke
- For Control Type "P":**
- 13a = CONTROL OPTIONS**
1 = Single Setting
2 = Dual Setting
A = Proportional Device, N.O.
B = Proportional Device, N.C.
C = Soft Start, N.O.
E = Electronic Displacement Control

- 13b = SOLENOID VOLTAGE**
N = Non-electrical Control Options
③ 0 = 115/60 - 110/50 VAC
③ 1 = 230/60 - 220/50 VAC
③ 2 = 12 VDC
③ 3 = 24 VDC
- 13c = CONNECTOR**
N = Non-electrical Control Options or No Connector
R = 1/2" NPT w/o Lite
① W = 1/2" NPT w/Lite
S = PG-11 w/o Lite
① L = PG-11 w/Lite

- 13d = CONTROL**
Blank unless required option
② F = Load Sense
②③ G = Load Sense with Horsepower Limiter
①③ H = Horsepower Limiter
② K = Load Sense Plus
②③ L = Horsepower Limiter with Load Sense Plus

<p>Legend</p> <ul style="list-style-type: none"> ① Not available with A or B Control Options ② Not available with pressure compensator options 2, A, B or C ③ Not available with pressure compensator option E
--

- 13e = INPUT HORSEPOWER @ 1800 RPM**
Blank unless required option
Example: 070 = 70 HP Input

- For Control Type "R":**
- 13a = TYPE**
U = Two Volume Control
- 13b = SOLENOID VOLTAGE**
N = Non-electrical Control Options
0 = 115/60 - 110/50 VAC
1 = 230/60 - 220/50 VAC
2 = 12 VDC
3 = 24 VDC
- 13c = CONNECTOR**
R = 1/2" NPT w/o Lite
W = 1/2" NPT w/Lite
S = PG-11 w/o Lite
L = PG-11 w/Lite

- For Control Type "V":**
- 13a = TYPE**
M = Single Stage
S = Two Stage
- 13b = SIZE**
20 = Servo Valve Size 20 (Type M)
25 = Servo Valve Size 25 (Type S)
- 14 = VOLUME STOPS**
NN = No Volume Stop
SA = Adjustable Minimum Volume Stop, Type "V" Controls Only
SB = Adjustable Maximum & Minimum Volume Stops, Type "R" Controls Only
SN = Adjustable Maximum Volume Stop, Not Available on Type "V" Controls

- 15 = AUXILIARY ADAPTERS**
Required for all thru-shaft units
Blank for all non-thru-shaft units
AA = 50-2 (SAE A-A) Adapter & 13-4 (SAE A-A) Coupling
AN = 82-2 (SAE A 2-Bolt) Adapter & 16-4 (SAE A) Coupling
BB = 101-2 (SAE B 2-Bolt) Adapter & 25-4 (SAE B-B) Coupling
BN = 101-2 (SAE B 2-Bolt) Adapter & 32-4 (SAE C) Coupling
CP = Cover Plate
NN = None

- 16 = GEAR PUMPS**
Blank unless required option
05 = 8 ml/rev. (0.488 cipr)
07 = 11 ml/rev. (0.672 cipr)
10 = 16 ml/rev. (0.976 cipr)
14 = 23 ml/rev. (1.403 cipr)
20 = 49 ml/rev. (2.015 cipr)

- 17 = SPECIAL PUMP MOD**
Assigned by factory if necessary

Subject to change without notice.

HOW TO ORDER





HOW TO ORDER - PVG 100, 130

BLOCK NUMBER EXPLANATION	1	2	3	-	4	-	5	6	7	-	8	9	10	11	-	12	-	13	14	-	15	/	16	-	17
VARIABLE PUMP EXAMPLE	P	V	G	-	100	-	F1	U	V	-	L	D	F	Y	-	P	-	1NN	SN	-	AN	/	05	-	-

- 1 = UNIT**
P = Pump
- 2 = TYPE**
V = Variable
- 3 = DESIGN SERIES**
G = Type
- 4 = UNIT SIZE**
100 = 100 ml/rev. (6.00 cipr)
130 = 130 ml/rev. (7.94 cipr)
- 5 = DESIGN SERIES**
F1 = Current
- 6 = DESIGN SERIES MODIFIER**
U = SAE Connections & Mounting
- 7 = SEALS**
V = Viton (Standard)
B = Buna Nitrile
P = EPR
- 8 = ROTATION**
L = Left Hand (CCW)
R = Right Hand (CW)
- 9 = VALVE PLATE TYPE**
G = Side Ported
D = Side Ported (thru-shaft)
S = Rear Ported
- 10 = CONNECTION TYPE**
F = Flange
- 11 = INPUT SHAFT TYPE**
Y = 38-1 (SAE C-C Keyed)
Z = 38-1 (SAE C-C Keyed),
1" Shorter than "Y"
S = 38-4 (SAE C-C Spline)
K = 32-4 (SAE C Spline)
R = 44-4 (SAE D Spline)
- 12 = CONTROL TYPE**
N = None
F = Fixed
P = Pressure Compensating
R = Solenoid Operated Volume
V = Electrohydraulic
(with feedback)

13 = CONTROL MODIFIER

13					
a	b	c	/	d	e

For Control Type "F":

13a, b, c CONTROL OPTIONS

- 075 = 75% Stroke
- 100 = 100% Stroke

For Control Type "P":

13a = CONTROL OPTIONS

- 1 = Single Setting
- 2 = Dual Setting
- A = Proportional Device, N.O.
- B = Proportional Device, N.C.
- C = Soft Start, N.O.
- E = Electronic Displacement Control

13b = SOLENOID VOLTAGE

- N = Non-electrical Control Options
- ③ 0 = 115/60 - 110/50 VAC
- ③ 1 = 230/60 - 220/50 VAC
- ③ 2 = 12 VDC
- 3 = 24 VDC

13c = CONNECTOR

- N = Non-electrical Control Options or No Connector
- R = 1/2" NPT w/o Lite
- ① W = 1/2" NPT w/Lite
- S = PG-11 w/o Lite
- ① L = PG-11 w/Lite

13d = CONTROL

- Blank unless required option
- ② F = Load Sense
- ②③ G = Load Sense with Horsepower Limiter
- ①③ H = Horsepower Limiter
- ② K = Load Sense Plus
- ②③ L = Horsepower Limiter with Load Sense Plus

Legend

- ① Not available with A or B Control Options
- ② Not available with pressure compensator options 2, A, B or C
- ③ Not available with pressure compensator option E

13e = INPUT HORSEPOWER @ 1800 RPM

- Blank unless required option
- Example: 070 = 70 HP Input

For Control Type "R":

13a = TYPE

- U = Two Volume Control

13b = SOLENOID VOLTAGE

- N = Non-electrical Control Options
- 0 = 115/60 - 110/50 VAC
- 1 = 230/60 - 220/50 VAC
- 2 = 12 VDC
- 3 = 24 VDC

13c = CONNECTOR

- R = 1/2" NPT w/o Lite
- W = 1/2" NPT w/Lite
- S = PG-11 w/o Lite
- L = PG-11 w/Lite

For Control Type "V":

13a = TYPE

- M = Single Stage
- S = Two Stage

13b = SIZE

- 20 = Servo Valve Size 20 (Type M)
- 25 = Servo Valve Size 25 (Type S)

14 = VOLUME STOPS

- NN = No Volume Stop
- SA = Adjustable Minimum Volume Stop, Type "V" Controls Only
- SB = Adjustable Maximum & Minimum Volume Stops, Type "R" Controls Only
- SN = Adjustable Maximum Volume Stop, Not Available on Type "V" Controls

15 = AUXILIARY ADAPTERS

Required for all thru-shaft units
Blank for all non-thru-shaft units

- AA = 50-2 (SAE A-A) Adapter & 13-4 (SAE A-A) Coupling
- AN = 82-2 (SAE A 2-Bolt) Adapter & 16-4 (SAE A) Coupling
- BB = 101-2 (SAE B 2-Bolt) Adapter & 25-4 (SAE B-B) Coupling
- BN = 101-2 (SAE B 2-Bolt) Adapter & 32-4 (SAE C) Coupling
- CN = 127-2 (SAE C 2-Bolt) Adapter & 32-4 (SAE C) Coupling
- CP = Cover Plate
- NN = None

16 = GEAR PUMPS

- Blank unless required option
- 05 = 8 ml/rev. (0.488 cipr)
- 07 = 11 ml/rev. (0.672 cipr)
- 10 = 16 ml/rev. (0.976 cipr)
- 14 = 23 ml/rev. (1.403 cipr)
- 20 = 49 ml/rev. (2.015 cipr)

17 = SPECIAL PUMP MOD

- Assigned by factory if necessary

HOW TO ORDER - PVG 150

BLOCK NUMBER EXPLANATION	1	2	3	-	4	-	5	6	7	-	8	9	10	11	-	12	-	13	14	-	15	/	16	-	17
VARIABLE PUMP EXAMPLE	P	V	G	-	150	-	A1	U	V	-	L	D	F	Y	-	P	-	1NN	SN	-	A2	/	05	-	-

- 1 = UNIT**
P = Pump
- 2 = TYPE**
V = Variable
- 3 = DESIGN SERIES**
G = Type
- 4 = UNIT SIZE**
150 = 150 ml/rev. (9.16 cipr)
- 5 = DESIGN SERIES**
A1 = Current
- 6 = DESIGN SERIES MODIFIER**
U = SAE Connections & Mounting
- 7 = SEALS**
V = Viton (Standard)
B = Hydrogenated Buna Nitrile
P = EPR
- 8 = ROTATION**
L = Left Hand (CCW)
R = Right Hand (CW)
- 9 = VALVE PLATE TYPE**
G = Side Ported
D = Side Ported (thru-shaft)
- 10 = CONNECTION TYPE**
F = Flange
- 11 = INPUT SHAFT TYPE**
L = 44-4 (SAE D Spline)
Y = 44-1 (SAE D Keyed)
- 12 = CONTROL TYPE**
P = Pressure Compensating
F = Fixed
V = Electrohydraulic (with feedback)

13 = CONTROL

13					
a	b	c	/	d	e

- For Control Type "F":**
- 13a, b, c CONTROL OPTIONS**
075 = 75% Stroke
100 = 100% Stroke
- For Control Type "P":**
- 13a = CONTROL OPTIONS**
1 = Single Setting
2 = Dual Setting
A = Proportional Device, N.O.
B = Proportional Device, N.C.
C = Soft Start, N.O.
E = Electronic Displacement Control

- 13b = SOLENOID VOLTAGE**
N = Non-electrical Control Options
- ③ 0 = 115/60 - 110/50 VAC
 - ③ 1 = 230/60 - 220/50 VAC
 - ③ 2 = 12 VDC
 - 3 = 24 VDC
- 13c = CONNECTOR**
N = Non-electrical Control Options or No Connector
R = 1/2" NPT w/o Lite
① W = 1/2" NPT w/Lite
S = PG-11 w/o Lite
① L = PG-11 w/Lite

- 13d = CONTROL MODIFIER**
Blank unless required option
- ② F = Load Sense
 - ②③ G = Load Sense with Horsepower Limiter
 - ①③ H = Horsepower Limiter
 - ② K = Load Sense Plus
 - ②③ L = Horsepower Limiter with Load Sense Plus

Legend
① Not available with A or B Control Options
② Not available with pressure compensator options 2, A, B or C
③ Not available with pressure compensator option E

- 13e = INPUT HORSEPOWER @ 1800 RPM**
Blank unless required option
Example: 070 = 70 HP Input

- For Control Type "V":**
- 13a = TYPE**
M = Single Stage
S = Two Stage
- 13b = SIZE**
20 = Servo Valve Size 20 (Type M)
25 = Servo Valve Size 25 (Type S)
- 14 = VOLUME STOPS**
NN = No Volume Stop
SA = Adjustable Minimum Volume Stop, Type "V" Controls Only
SN = Adjustable Maximum Volume Stop, Not Available on Type "V" Controls
- 15 = AUXILIARY ADAPTERS**
Required for all thru-shaft units
Blank for all non-thru-shaft units
- AA = 50-2 (SAE A-A) Adapter & Coupling
 - A2 = 82-2 (SAE A 2-Bolt) Adapter & 16-4 (SAE A) Coupling
 - B2 = 101-2 (SAE B 2-Bolt) Adapter & 22-4 (SAE B) Coupling
 - B4 = 101-4 (SAE B 4-Bolt) Adapter & 22-4 (SAE B) Coupling
 - C2 = 127-2 (SAE C 2-Bolt) Adapter & 32-4 (SAE C) Coupling
 - C4 = 127-4 (SAE C 4-Bolt) Adapter & 32-4 (SAE C) Coupling
 - D4 = 152-4 (SAE D 4-Bolt) Adapter & 44-4 (SAE D) Coupling
 - CP = Cover Plate
 - NN = None
- 25-4 (SAE B-B) & 38-4 (SAE C-C)
Couplings also available as special order.

- 16 = GEAR PUMPS**
Blank unless required option
- 05 = 8 ml/rev. (0.488 cipr)
 - 07 = 11 ml/rev. (0.672 cipr)
 - 10 = 16 ml/rev. (0.976 cipr)
 - 14 = 23 ml/rev. (1.403 cipr)
 - 20 = 49 ml/rev. (2.015 cipr)
- 17 = SPECIAL PUMP MOD**
Assigned by factory if necessary

HOW TO ORDER

25



HOW TO ORDER - PVG 180

BLOCK NUMBER EXPLANATION	P	V	G	-	xxx	-	5	6	7	-	8	9	10	11	-	12	-	13	14	-	15	/	16	-	17
VARIABLE PUMP EXAMPLE	P	V	G	-	180	-	A1	U	V	-	L	D	F	S	-	P	-	1NN	SN	-	AN	/	O5	-	-

1 = UNIT
P = Pump

2 = TYPE
V = Variable

3 = DESIGN TYPE

4 = UNIT SIZE
180 = 180 cc/rev. (10.99 cipr)

5 = DESIGN SERIES
A1 = Current for all displacements

6 = DESIGN SERIES MODIFIER
U = SAE Connections & Mounting

7 = SEALS
V = Viton (Standard)
P = EPR
B = Buna Nitrile

8 = ROTATION
L = Left Hand (CCW)
R = Right Hand (CW)

9 = VALVE PLATE TYPE
G = Side Ported
D = Side Ported (thru-shaft)

10 = CONNECTION TYPE
F = SAE Flange

11 = SHAFT TYPE
Y = 44-1 (SAE D Keyed)
S = 44-4 (SAE D Spline)

For Control Type "P":

13a = CONTROL OPTIONS

1 = Single Setting

Control

13b = SOLENOID VOLTAGE
N = Non-electrical Control

13c = CONNECTOR
N = Non-electrical Control
Options or No Connector

13d = CONTROL MODIFIER
Blank unless required option
F = Load Sense

14 = VOLUME STOPS

NN = No Volume Stop
SA = Adjustable Minimum
Volume Stop, Type "V"
Controls Only
SN = Adjustable Maximum
Volume Stop, Not Available
on Type "V" Controls

15 = AUXILIARY ADAPTERS Required for all thru-shaft units for all non-thru-shaft units

NN = None
A2 = 82-2 (SAE A 2-Bolt)
Adapter & 16-4 (SAE A) Coupling
B2 = 101-2 (SAE B 2-Bolt)
Adapter & 22-4 (SAE B) Coupling
B4 = 101-4 (SAE B 4-Bolt)
Adapter & 22-4 (SAE B) Coupling
C2 = 127-2 (SAE C 2-Bolt)
Adapter & 32-4 (SAE C) Coupling

16 = GEAR PUMPS

Blank unless required
05 = 8 ml/rev. (0.488 cipr)
07 = 11 ml/rev. (0.672 cipr)
10 = 16 ml/rev. (0.976 cipr)
14 = 23 ml/rev. (1.403 cipr)
20 = 49 ml/rev. (2.015 cipr)

17 = SPECIAL PUMP MOD

Assigned by factory if necessary



Installation Drawings	048, 065, 075 Series F1	100, 130 Series F1	150 Series A1	180 Series A1
Pumps				
Basic Pump Rear Ported	DS-47952	DS-47922		
Basic Pump Side Ported (Top and Bottom)	DS-47953	DS-47943	DS-47375	
Basic Pump Thru Shaft	DS-47954	DS-47944	DS-47376	DS-48376
Dual Pump Adapter - 2 Bolt	DS-47958	DS-47946	DS-47387	DS-48387
Dual Pump Adapter - 4 Bolt SAE J744			DS-47388	
Controls				
Fixed Delivery	DS-47549	DS-47548		
P-1NN Single Pressure Compensator	DS-47551	DS-47541	DS-47377	DS-48377
P-1NN/F Single Pressure Compensator w/Load Sense	DS-47552	DS-47542	DS-47378	DS-48378
P-1NN/H Single Pressure Compensator w/Horsepower Limiter	DS-47553	DS-47543	DS-47380	
P-1NN/G Single Pressure Compensator w/Horsepower Limiter w/Load Sense	DS-47554	DS-47544	DS-47379	
P-1NN/K Single Pressure Compensator w/Load Sense Plus	DS-47621	DS-47350	DS-47385	
P-1NN/L Single Pressure Compensator w/Horsepower Limiter w/Load Sense Plus	DS-47622	DS-47351	DS-47386	
P-C Single Pressure Soft Start	DS-47557	DS-47547	DS-47382	
P-CXX/H Single Pressure Soft Start w/Horsepower Limiter	DS-47618	DS-47521	DS-47389	
P-2 Dual Pressure Compensator	DS-47555	DS-47545	DS-47381	
P-2XX/H Dual Pressure Compensator w/Horsepower Limiter	DS-47617	DS-47520	DS-47390	
P-ANX (N.O.) or P-BNX (N.C.) Electronic Proportional Pressure Compensator	DS-47556	DS-47546	DS-47383	
V-S 2-Stage Servo Valve	DS-47615	DS-47719		
V-M Single Stage Servo Valve	DS-47616	DS-47522		
P-E Electronic Displacement Control (EDC)	DS-47619	DS-47860	DS-47384	
P-E/F Electronic Displacement Control (EDC) W/Load Sense	DS-47620	DS-47861	DS-47389	

For additional technical information refer to the Application Guidelines bulletin 847019

Current versions of the documents referenced in this bulletin may have a letter at the end to denote the revision level. To get the latest release of any of any document, including this one, go to the Technical Library section of the Oilgear website - www.oilgear.com.



World Headquarters

The Oilgear Company

1424 International Dr, Traverse City, MI 49686

phone: 231.929.1660 www.oilgear.com

For more information about your application or the products in this brochure, please contact your nearest Oilgear facility.





Our international sales network covers every jurisdiction. Our global shipping partners mean you can be sure we're on hand whenever you need us.

Zeus Hydratech Ltd

Unit 35
Old Mills Industrial Estate
Paulton
Bristol, BS39 7SU
United Kingdom

T. +44 (0) 1172 130042
E: info@zeushydratech.com
W. www.zeushydratech.com